

Bench

• PANNELLI FRONTALI

MATERIALE: Pannello di particelle di legno sp. 25mm o metacrilato sp. 5 mm

FINITURA: Disponibile in 3 tipologie

1) Nobilitato in melaminico: Argento Golf, Noce Hari, Bianco Frassino, Acero Taki, Bianco Br., Wengè, Antracite

2) Rivestito in tessuto, colori Forsit (Cat. F):

Poliestere Stretch Ignifugo

3) Metacrilato: bianco

CARATTERISTICA: Dotato di binario o barra attrezzabile per alloggiamento accessori.

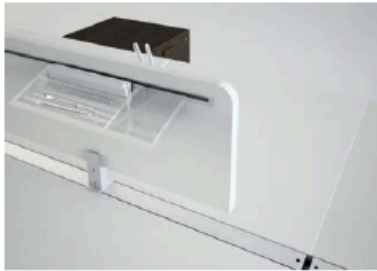

• FRONT PANELS

MATERIAL: Particleboard panel 25mm thick or methacrylate 5mm thick

FINISH: Available in 3 kinds:

1) Melamine-faced: Golf Silver, Hari Walnut, Ash White, Taki Maple, Br. White, Wengè, Anthracite

2) Covered by fabric, Forsit colours (Cat. F):

Fire-retardant Stretch Polyester

3) Methacrylate: White

FEATURE: Binary or aluminium toolbar included to hook-up the accessories.

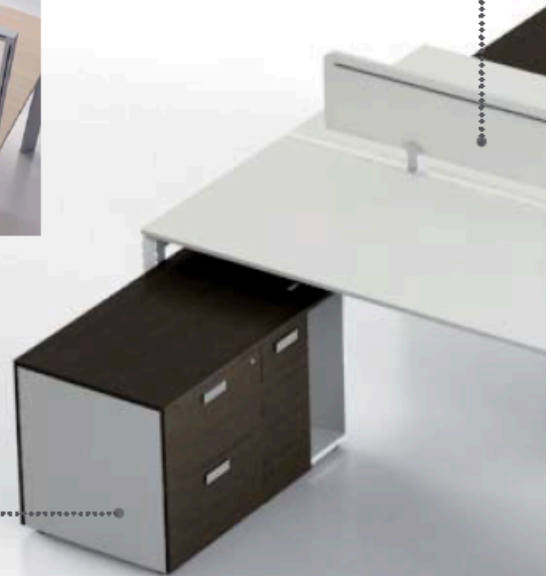

• MOBILI DI SERVIZIO E PORTA-CPU

MATERIALE: Pannello di particelle di legno sp. 18mm

FINITURA: Nobilitato in melaminico

COLORI:

Struttura: Argento Golf, Bianco Br., Antracite

Frontali, top e schiena: Noce Hari, Bianco Frassino, Antracite, Acero Taki, Bianco Br., Wengè, Argento Golf, Rosso, Azzurro, Giallo, Verde acido, Arancio.

CARATTERISTICA: Consente l'alloggiamento del PC-Tower e il cablaggio tramite aperture sulla base. Dotato di piedini livellatori. Possibilità di utilizzo come freestanding.

• SERVICE UNITS AND CPU-HOLDER

MATERIAL: Particleboard panel 18 mm thick.

FINISH: Melamine-faced

COLOURS:

Structure: Golf Silver, Br. White, Anthracite

Fronts, top and back panel: Hari Walnut, Ash White, Anthracite, Taki Maple, Br. White, Wengè, Golf Silver, Red, Blue, Yellow, Acid green, Orange

FEATURE: It allows the PC-Tower lodging and the wire-manager through a bottom opening.

Adjustable feet included. The service units can be used as freestanding.

• PIANI DI LAVORO

MATERIALE: Pannello di particelle di legno sp. 18mm (possibilità di utilizzo pannelli di sp. 25mm)
FINITURA: Nobilitato in melaminico
COLORI: Noce Hari, Bianco Frassino, Acero Taki, Bianco Br., Wengè

• WORK TOPS

MATERIAL: Particleboard panel 18mm thick. (25mm thick tops available)
FINISH: Melamine-faced
COLOURS: Hari Walnut, Ash White, Taki Maple, Br. White, Wengè



• GAMBA METALLICA A PONTE

MATERIALE: Tubolare metallico a sezione trapezoidale
FINITURA: Verniciatura a polveri epossidiche nei colori: Argento, Bianco, Antracite
CARATTERISTICA: Predisposta per il fissaggio delle travi portanti. Dotata di piedini livellatori.

• BRIDGE METAL LEG

MATERIAL: Metallic tubular with trapezoidal section
FINISH: Painted with epoxy resin powder in colours: Silver, White, Anthracite
FEATURE: The leg is predisposed for to fix the supporting beams. Adjustable feet included.



• TRAVI DI SOSTEGNO

MATERIALE: Tubolare metallico a sezione rettangolare
FINITURA: Verniciatura a polveri epossidiche nel colore Argento
CARATTERISTICA: Predisposte per il fissaggio delle gambe ponte e dei piani.

• SUPPORTING BEAMS

MATERIAL: Metallic tubular with rectangular section
FINISH: Painted with epoxy resin powder in Silver colour
FEATURE: The beams are predisposed for to fix the bridge legs and the work tops.



• GAMBA CENTRALE WIRE-MANAGER

MATERIALE: Struttura in tubolare metallico e pannelli di tamponamento in lamiera metallica
FINITURA: Verniciatura a polveri epossidiche nei colori: Argento, Bianco, Antracite
CARATTERISTICA: Consente il cablaggio tramite aperture laterali. Dotata di pannelli laterali ispezionabili. Predisposta per il fissaggio delle travi portanti e dei piani. Dotata di piedini livellatori.

• CENTRAL WIRE-MANAGER LEG

MATERIAL: Metallic tubular structure and panels in metal sheet.
FINISH: Painted with epoxy resin powder in colours: Silver, White, Anthracite
FEATURE: It allows the wire-manager through a lateral opening. The leg is predisposed for to fix the supporting beams and the work tops. Adjustable feet included.

Bench

• PORTA-CPU

MATERIALE: Pannello di particelle di legno sp. 18mm
FINITURA: Nobilitato in melaminico
COLORI:
Struttura: Argento Golf, Bianco Br., Antracite
Top e schiena: Noce Hari, Bianco Frassino, Antracite, Acero Taki, Bianco Br., Wengè, Argento Golf, Rosso, Azzurro, Giallo, Verde acido, Arancio.
CARATTERISTICA: Consente l'alloggiamento del PC-Tower e il cablaggio tramite aperture sulla base. Dotato di piedini livellatori.
Possibilità di utilizzo come sostegno strutturale sottopiano ,completando la composizione, con staffe fornite separatamente.



• CPU-HOLDER

MATERIAL: Particleboard panel 18 mm thick.
FINISH: Melamine-faced
COLOURS:
Structure: Golf Silver, Br. White, Anthracite
Top and back panel: Hari Walnut, Ash White, Anthracite, Taki Maple, Br. White, Wengè, Golf Silver, Red, Blue, Yellow, Acid green, Orange
FEATURE: It allows the PC-Tower lodging and the wire-manager through a bottom opening.
Adjustable feet included.
The CPU-holder can be used as support (with stirrups not included in the box).

• COPERTURA PER BENCH

MATERIALE: Profilo in plastica estrusa
COLORE: Argento
CARATTERISTICA: Predisposizione per il fissaggio di pannelli frontali, mensole e lampade.

• COVER FOR BENCH

MATERIAL: Extruded plastic profile
COLOURS: Silver
FEATURE: It is predisposed for to fix the front panels, shelves and lamps.

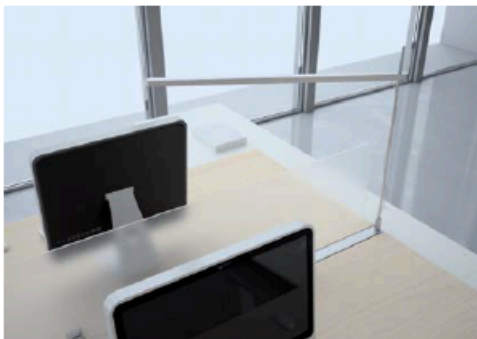

• TRAVI DI SOSTEGNO

MATERIALE: Tubolare metallico a sezione rettangolare

FINITURA: Verniciatura a polveri epossidiche nel colore Argento

CARATTERISTICA: Predisposte per il fissaggio delle gambe ponte e dei piani.

• SUPPORTING BEAMS

MATERIAL: Metallic tubular with rectangular section
FINISH: Painted with epoxy resin powder in Silver colour

FEATURE: The beams are predisposed for to fix the bridge legs and the tops.

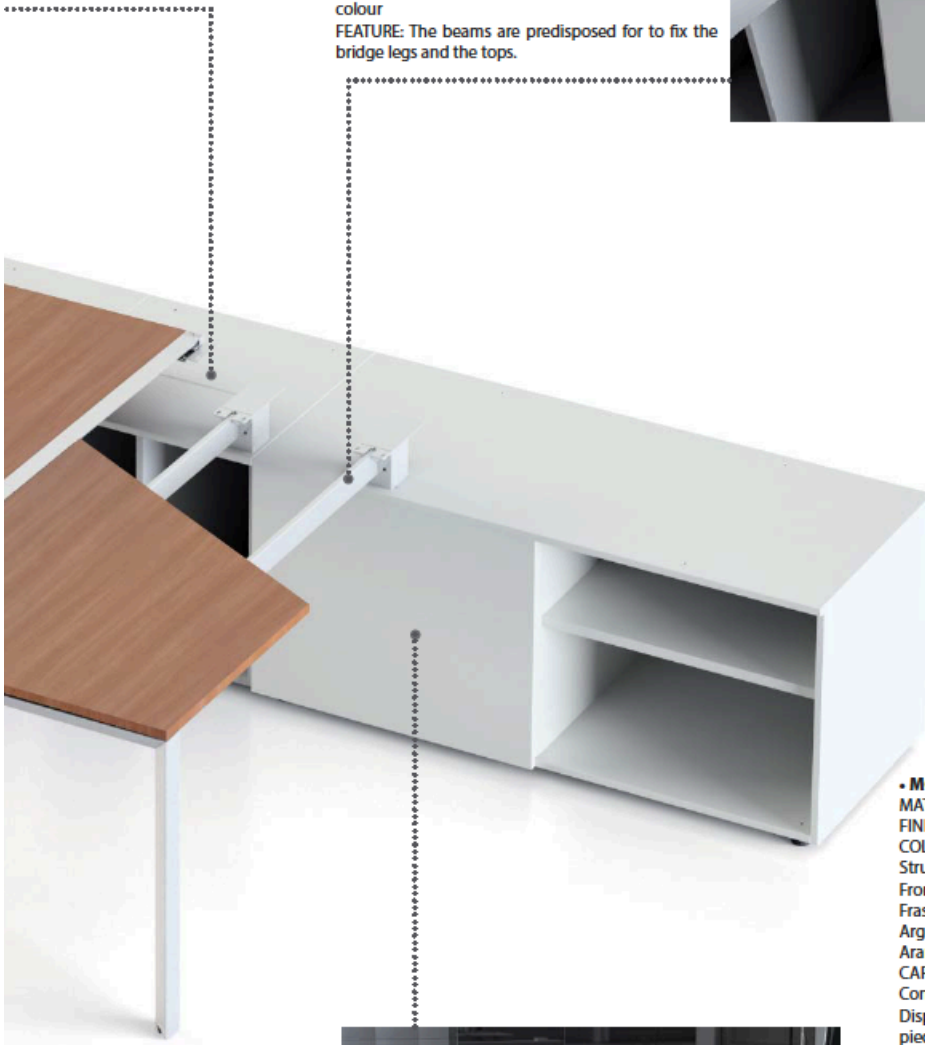

• MOBILI DI SERVIZIO CON ANTA SCORREVOLE

MATERIALE: Pannello di particelle di legno sp. 18mm
FINITURA: Nobilitato in melaminico

COLORI:

Struttura: Argento Golf, Bianco Br., Antracite
Frontali, top e schiena: Noce Hari, Bianco Frassino, Antracite, Acero Taki, Bianco Br., Wengè, Argento Golf, Rosso, Azzurro, Giallo, Verde acido, Arancio.

CARATTERISTICA:

Con vano porta-oggetti e anta scorrevole.
Disponibile mono-facciale e bi-facciale. Dotato di piedini livellatori.
Possibilità di utilizzo come freestanding o come sostegno strutturale sottopiano.

• SERVICE UNITS WITH SLIDING DOOR

MATERIAL: Particleboard panel 18 mm thick.

FINISH: Melamine-faced

COLOURS:

Structure: Golf Silver, Br. White, Anthracite
Fronts, top and back panel: Hari Walnut, Ash White, Anthracite, Taki Maple, Br. White, Wengè, Golf Silver, Red, Blue, Yellow, Acid green, Orange

FEATURE:

With glove-compartment and sliding door.
It is available one-side or double-side. Adjustable feet included.

The service units can be used as freestanding or to support.



ESEMPI DI AGGREGAZIONE SCRIVANIE CON GAMBE A PONTE E TIPO BENCH
examples of composition desks with bridge metal legs and BENCH

BENCH (1 POSTAZIONE)
bench (1 desk)

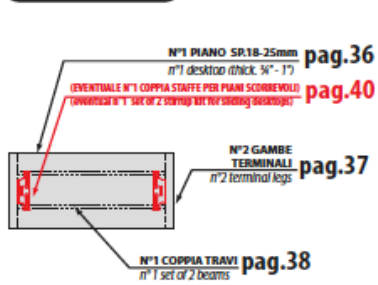

BENCH (3 POSTAZIONI)
bench (3 desk)

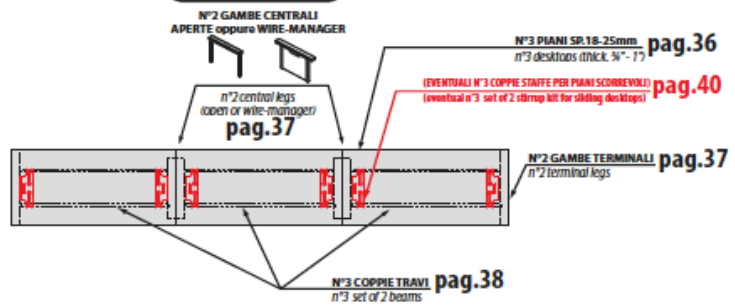

BENCH (2 POSTAZIONI)
bench (2 desk)

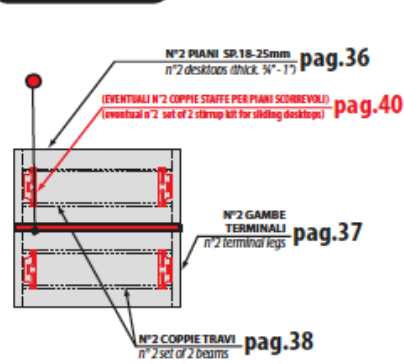

BENCH (6 POSTAZIONI)
bench (6 desk)

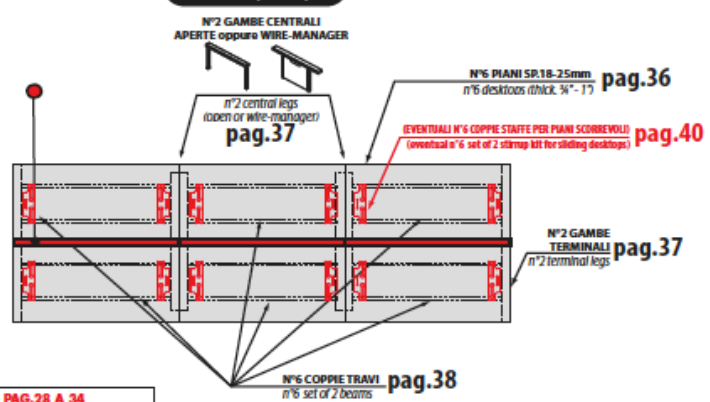



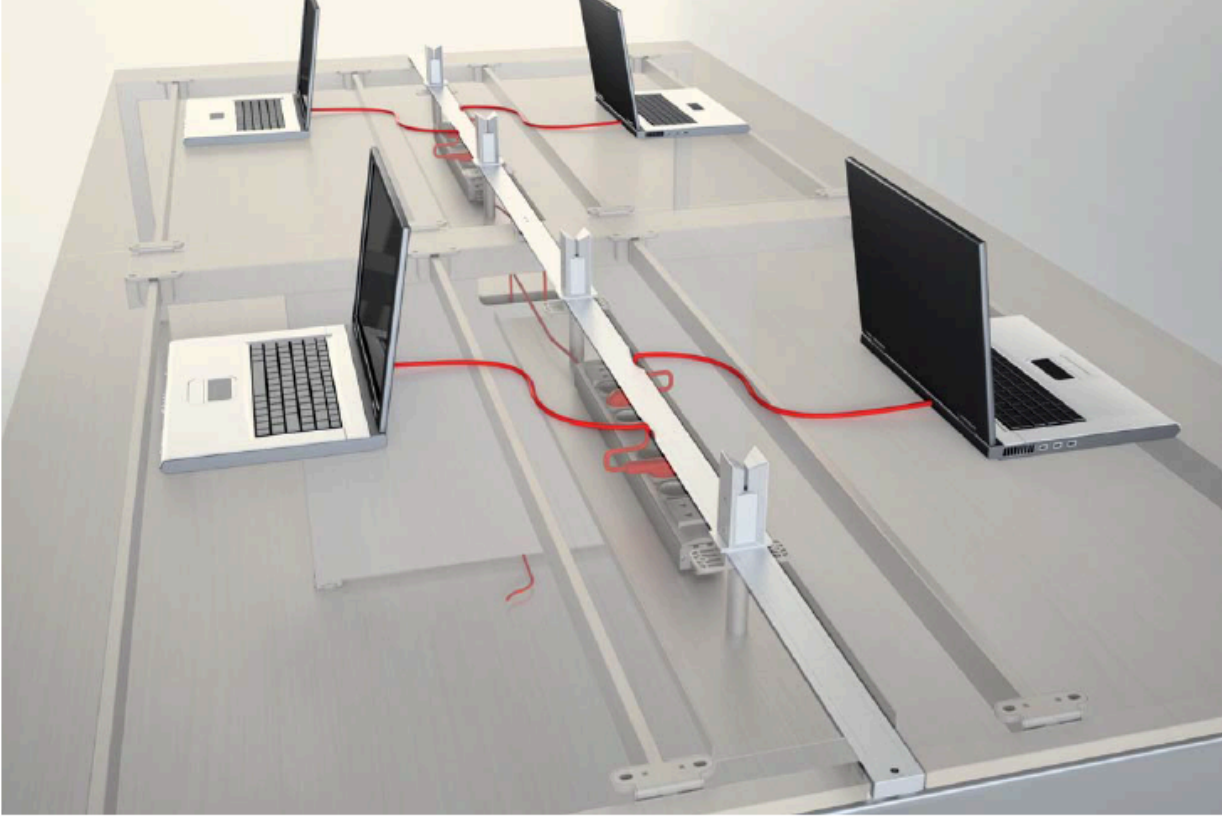

● PER COPERTURE CENTRALI e PANNELLI FRONTALI VEDI DA PAG.28 A 34
 for central covers and front panels, please see pages from 28 to 34

• ESEMPIO ELETRIFICAZIONE COMPLESSIVA DEL BENCH
 • EXAMPLE ELECTRIFICATION BENCH

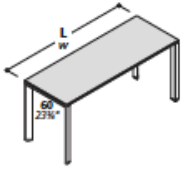
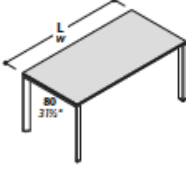
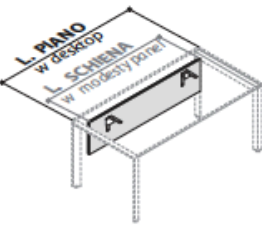

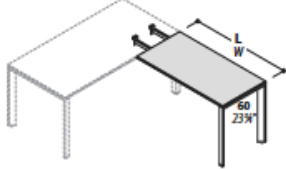
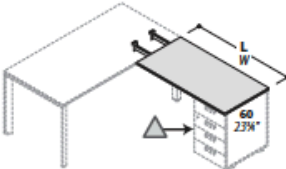
SCRIVANIE SINGOLE CON GAMBE METALLICHE A PONTE (PIANI BORDATI SP. MM 18 MELAMINICO)
single desks with bridge metal legs (square edged melamine tops thick. 3/4")

DESCRIZIONE <i>description</i>	L	w	CODICE <i>code</i>	KG	M ³	COLLI <i>pcs</i>	PREZZO <i>price</i>	CODICE FINITURA (*) <i>finish code (*)</i>																																																																																		
				lb	ff ³			PIANO	STRUTTURA	top	structure																																																																															
SCRIVANIE PROF. CM 60 <i>desks deep 23 3/4"</i>  L x p.60 x H.72,8 <i>width x d 23 3/4" x h 28 3/4"</i>	L120 w 47 1/4"	153 003 (*)	28 67	0,127 4,49	4																																																																																					
	L140 w 55 1/4"	153 004 (*)	30 66	0,136 4,81	4																																																																																					
	L160 w 63"	153 005 (*)	33 72	0,143 5,05	4																																																																																					
	L180 w 71"	153 006 (*)	36 79	0,148 5,23	4																																																																																					
SCRIVANIE PROF. CM 80 <i>desks deep 31 1/2"</i>  L x p.80 x H.72,8 <i>width x d 31 1/2" x h 28 3/4"</i>	L120 w 47 1/4"	153 020 (*)	33 72	0,163 5,76	4																																																																																					
	L140 w 55 1/4"	153 021 (*)	34 74	0,173 6,11	4																																																																																					
	L160 w 63"	153 022 (*)	37 81	0,182 6,43	4																																																																																					
	L180 w 71"	153 023 (*)	40 88	0,188 6,64	4																																																																																					
SCHIENE PER SCRIVANIE <i>modesty panels for desks</i>  L x p.1,8 x H.30 <i>width x d 3/4" x h 11 3/4"</i>	L107 w 42 1/4"	L120 w 47 1/4"	152 473 (*)	7 15	0,020 0,71	2																																																																																				
	L127 w 50"	L140 w 55 1/4"	152 474 (*)	8 17	0,023 0,81	2																																																																																				
	L147 w 58"	L160 w 63"	152 476 (*)	9 19	0,026 0,92	2																																																																																				
	L167 w 65 1/4"	L180 w 71"	152 477 (*)	10 22	0,029 1,02	2																																																																																				
 LE SCHIENE NON SONO UTILIZZABILI IN PRESENZA DI PANNELLI FRONTALI DO NOT USE MODESTY PANEL TOGETHER WITH THE FRONT PANEL																																																																																										
ALLUNGHI CON GAMBE METALLICHE A PONTE (PIANI BORDATI SP. MM 18 MELAMINICO) <i>extensions with bridge metal legs (square edged melamine tops thick. 3/4")</i>																																																																																										
ALLUNGHI <i>extensions</i>  L x p.60 x H.72,8 <i>width x d 23 3/4" x h 28 3/4"</i>	L80 w 31 1/2"	153 013 (*)	17 37	0,084 2,97	4																																																																																					
	L100 w 39 1/2"	153 014 (*)	20 44	0,094 3,32	4																																																																																					
	L120 w 47 1/4"	153 010 (*)	24 52	0,102 3,60	4																																																																																					
ALLUNGHI PER CASSETTIERA-BASE <i>extensions for base-pedestal</i>  L x p.60 x H.1,8 <i>width x d 23 3/4" x h 3/4"</i>	L80 w 31 1/2"	153 018 (*)	9,5 20	0,045 1,69	3																																																																																					
	L100 w 39 1/2"	153 019 (*)	12 26	0,052 1,84	3																																																																																					
	L120 w 47 1/4"	153 015 (*)	15 33	0,062 2,19	3																																																																																					
 COMPLETARE SEMPRE CON CASSETTIERA-BASE ART.444-445-764-775 PAG.68 to be always complete with base-pedestal art.444-445-764-775 page 68																																																																																										
<table border="1"> <thead> <tr> <th>(*)</th> <th>PIANO</th> <th>STRUTTURA</th> <th>top</th> <th>structure</th> </tr> </thead> <tbody> <tr><td>017</td><td>NOCE HARI</td><td>ARGENTO</td><td>hazl walnut</td><td>silver</td></tr> <tr><td>020</td><td>ACERO TAKI</td><td>ARGENTO</td><td>takl maple</td><td>silver</td></tr> <tr><td>027</td><td>BIANCO FRASSINO</td><td>ARGENTO</td><td>ash white</td><td>silver</td></tr> <tr><td>040</td><td>BIANCO BR.</td><td>ARGENTO</td><td>br. white</td><td>silver</td></tr> <tr><td>090</td><td>WENGE'</td><td>ARGENTO</td><td>wangl</td><td>silver</td></tr> <tr><td>400</td><td>BIANCO BR.</td><td>BIANCO</td><td>br. white</td><td>white</td></tr> <tr><td>417</td><td>NOCE HARI</td><td>BIANCO</td><td>hazl walnut</td><td>white</td></tr> <tr><td>420</td><td>ACERO TAKI</td><td>BIANCO</td><td>takl maple</td><td>white</td></tr> <tr><td>427</td><td>BIANCO FRASSINO</td><td>BIANCO</td><td>ash white</td><td>white</td></tr> <tr><td>490</td><td>WENGE'</td><td>BIANCO</td><td>wangl</td><td>white</td></tr> <tr><td>517</td><td>NOCE HARI</td><td>ANTRACITE</td><td>hazl walnut</td><td>anfractal</td></tr> <tr><td>520</td><td>ACERO TAKI</td><td>ANTRACITE</td><td>takl maple</td><td>anfractal</td></tr> <tr><td>527</td><td>BIANCO FRASSINO</td><td>ANTRACITE</td><td>ash white</td><td>anfractal</td></tr> <tr><td>540</td><td>BIANCO BR.</td><td>ANTRACITE</td><td>br. white</td><td>anfractal</td></tr> <tr><td>590</td><td>WENGE'</td><td>ANTRACITE</td><td>wangl</td><td>anfractal</td></tr> </tbody> </table>											(*)	PIANO	STRUTTURA	top	structure	017	NOCE HARI	ARGENTO	hazl walnut	silver	020	ACERO TAKI	ARGENTO	takl maple	silver	027	BIANCO FRASSINO	ARGENTO	ash white	silver	040	BIANCO BR.	ARGENTO	br. white	silver	090	WENGE'	ARGENTO	wangl	silver	400	BIANCO BR.	BIANCO	br. white	white	417	NOCE HARI	BIANCO	hazl walnut	white	420	ACERO TAKI	BIANCO	takl maple	white	427	BIANCO FRASSINO	BIANCO	ash white	white	490	WENGE'	BIANCO	wangl	white	517	NOCE HARI	ANTRACITE	hazl walnut	anfractal	520	ACERO TAKI	ANTRACITE	takl maple	anfractal	527	BIANCO FRASSINO	ANTRACITE	ash white	anfractal	540	BIANCO BR.	ANTRACITE	br. white	anfractal	590	WENGE'	ANTRACITE	wangl	anfractal
(*)	PIANO	STRUTTURA	top	structure																																																																																						
017	NOCE HARI	ARGENTO	hazl walnut	silver																																																																																						
020	ACERO TAKI	ARGENTO	takl maple	silver																																																																																						
027	BIANCO FRASSINO	ARGENTO	ash white	silver																																																																																						
040	BIANCO BR.	ARGENTO	br. white	silver																																																																																						
090	WENGE'	ARGENTO	wangl	silver																																																																																						
400	BIANCO BR.	BIANCO	br. white	white																																																																																						
417	NOCE HARI	BIANCO	hazl walnut	white																																																																																						
420	ACERO TAKI	BIANCO	takl maple	white																																																																																						
427	BIANCO FRASSINO	BIANCO	ash white	white																																																																																						
490	WENGE'	BIANCO	wangl	white																																																																																						
517	NOCE HARI	ANTRACITE	hazl walnut	anfractal																																																																																						
520	ACERO TAKI	ANTRACITE	takl maple	anfractal																																																																																						
527	BIANCO FRASSINO	ANTRACITE	ash white	anfractal																																																																																						
540	BIANCO BR.	ANTRACITE	br. white	anfractal																																																																																						
590	WENGE'	ANTRACITE	wangl	anfractal																																																																																						
<table border="1"> <thead> <tr> <th>(*)</th> <th>SCHIENE</th> <th>modesty panels</th> </tr> </thead> <tbody> <tr><td>000</td><td>ARGENTO GOLF</td><td>golf silver</td></tr> <tr><td>400</td><td>BIANCO BR.</td><td>br. white</td></tr> <tr><td>550</td><td>ANTRACITE</td><td>anfractal</td></tr> </tbody> </table>											(*)	SCHIENE	modesty panels	000	ARGENTO GOLF	golf silver	400	BIANCO BR.	br. white	550	ANTRACITE	anfractal																																																																				
(*)	SCHIENE	modesty panels																																																																																								
000	ARGENTO GOLF	golf silver																																																																																								
400	BIANCO BR.	br. white																																																																																								
550	ANTRACITE	anfractal																																																																																								
<table border="1"> <thead> <tr> <th>(*)</th> <th>PIANO</th> <th>top</th> </tr> </thead> <tbody> <tr><td>170</td><td>NOCE HARI</td><td>hazl walnut</td></tr> <tr><td>200</td><td>ACERO TAKI</td><td>takl maple</td></tr> <tr><td>270</td><td>BIANCO FRASSINO</td><td>ash white</td></tr> <tr><td>400</td><td>BIANCO BR.</td><td>br. white</td></tr> <tr><td>900</td><td>WENGE'</td><td>wangl</td></tr> </tbody> </table>											(*)	PIANO	top	170	NOCE HARI	hazl walnut	200	ACERO TAKI	takl maple	270	BIANCO FRASSINO	ash white	400	BIANCO BR.	br. white	900	WENGE'	wangl																																																														
(*)	PIANO	top																																																																																								
170	NOCE HARI	hazl walnut																																																																																								
200	ACERO TAKI	takl maple																																																																																								
270	BIANCO FRASSINO	ash white																																																																																								
400	BIANCO BR.	br. white																																																																																								
900	WENGE'	wangl																																																																																								

BENCH PROF.60+60 (PIANI BORDATI SP. MM 18 MELAMINICO)
bench deep 23 3/4" + 23 3/4" (square edged melamine tops thick. 3/4")

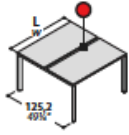
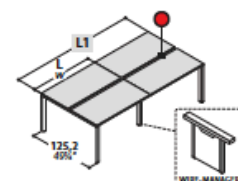
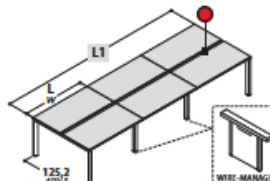
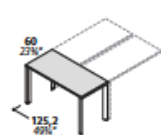
DESCRIZIONE <i>description</i>	L	w	CODICE <i>code</i>	KG <i>lb</i>	M ³ <i>ft³</i>	COLLI <i>pcs</i>	PREZZO <i>price</i>	CODICE FINITURA (*) <i>finish code (*)</i>	
BENCH PROF. CM 60+60 bench deep 23 3/4" + 23 3/4"  L x p.125,2 x H.72,8 width x d 49 1/4" x h 28 3/4"	L1								
	L120 w 47 1/4"		153 055 (*)	50 110	0,261 0,22	6			
	L140 w 55 1/4"		153 056 (*)	54 119	0,277 0,79	6			
	L160 w 63"		153 057 (*)	60 132	0,292 0,32	6			
	L180 w 71"		153 058 (*)	66 145	0,302 0,67	6			
BENCH PROF. CM 60+60 bench deep 23 3/4" + 23 3/4"  L1 x p.125,2 x H.72,8 L1 x d 49 1/4" x h 28 3/4"	L1		CON GAMBA CENTRALE APERTA <i>with open central leg</i>						
	L240 w 54 1/2"	L120 w 47 1/4"	153 060 (*)	89 196	0,476 16,82	11			
	L280 w 110 1/4"	L140 w 55 1/4"	153 061 (*)	97 213	0,509 17,99	11			
	L320 w 128"	L160 w 63"	153 062 (*)	109 240	0,539 19,05	11			
	L360 w 147 3/4"	L180 w 71"	153 063 (*)	121 266	0,559 19,75	11			
	L1		CON GAMBA CENTRALE WIRE-MANAGER <i>with central wire-manager leg</i>						
	L240 w 54 1/2"	L120 w 47 1/4"	153 065 (*)	89 196	0,476 16,82	11			
	L280 w 110 1/4"	L140 w 55 1/4"	153 066 (*)	97 213	0,509 17,99	11			
	L320 w 128"	L160 w 63"	153 067 (*)	109 240	0,539 19,05	11			
	L360 w 147 3/4"	L180 w 71"	153 068 (*)	121 266	0,559 19,75	11			
	BENCH PROF. CM 60+60 bench deep 23 3/4" + 23 3/4"  L1 x p.125,2 x H.72,8 L1 x d 49 1/4" x h 28 3/4"	L1		CON GAMBE CENTRALI APERTE <i>with open central legs</i>					
L360 w 147 3/4"		L120 w 47 1/4"	153 070 (*)	128 282	0,691 24,42	16			
L420 w 165 1/2"		L140 w 55 1/4"	153 071 (*)	140 308	0,741 26,18	16			
L480 w 183"		L160 w 63"	153 072 (*)	158 348	0,786 27,77	16			
L540 w 212 3/4"		L180 w 71"	153 073 (*)	176 388	0,816 28,83	16			
L1		CON GAMBE CENTRALI WIRE-MANAGER <i>with central wire-manager legs</i>							
L360 w 147 3/4"		L120 w 47 1/4"	153 075 (*)	128 282	0,691 24,42	16			
L420 w 165 1/2"		L140 w 55 1/4"	153 076 (*)	140 308	0,741 26,18	16			
L480 w 183"		L160 w 63"	153 077 (*)	158 348	0,786 27,77	16			
L540 w 212 3/4"		L180 w 71"	153 078 (*)	176 388	0,816 28,83	16			
SCRIVANIA TERMINALE PER BENCH PROF. CM 60+60 terminal desk for bench deep 23 3/4" + 23 3/4"  L 125,2 x p.60 x H.72,8 w 49 1/4" x d 23 3/4" x h 28 3/4"		L1							
	L125,2 w 47 1/4"		153 089 (*)	27 59	0,133 4,70	4			

(*)	PIANO	STRUTTURA	top	structure
017	NOCE HARI	ARGENTO	hari/walnut	silver
020	ACERO TAKI	ARGENTO	taki/maple	silver
027	BIANCO FRASSINO	ARGENTO	ash/white	silver
040	BIANCO BR.	ARGENTO	br. white	silver
090	WENGÈ	ARGENTO	wenge	silver
400	BIANCO BR.	BIANCO	br. white	white
417	NOCE HARI	BIANCO	hari/walnut	white
420	ACERO TAKI	BIANCO	taki/maple	white
427	BIANCO FRASSINO	BIANCO	ash/white	white
490	WENGÈ	BIANCO	wenge	white
517	NOCE HARI	ANTRACITE	hari/walnut	anthracite
520	ACERO TAKI	ANTRACITE	taki/maple	anthracite
527	BIANCO FRASSINO	ANTRACITE	ash/white	anthracite
540	BIANCO BR.	ANTRACITE	br. white	anthracite
590	WENGÈ	ANTRACITE	wenge	anthracite

BENCH PROF.80+80 (PIANI BORDATI SP. MM 18 MELAMINICO)
bench deep 31½"+31½" (square edged melamine tops thick. ¾")

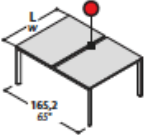
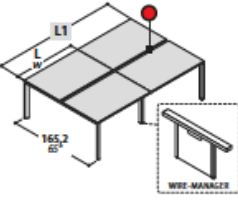
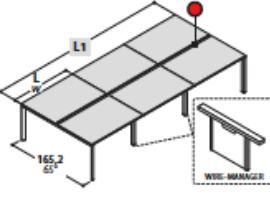
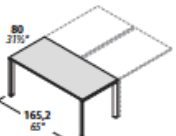
DESCRIZIONE <i>description</i>	L	w	CODICE <i>code</i>	KG <i>lb</i>	M ³ <i>ff³</i>	COLLI <i>pcs</i>	PREZZO <i>price</i>	CODICE FINITURA (*) <i>finish code (*)</i>	
BENCH PROF. CM 80+80 bench deep 31½"+31½"  L x p.165,2 x H.72,8 width x d 65" x h 28¾"	L1								
		L120 w 47½"	153 090 (*)	56 123	0,323 11,41	6			
		L140 w 55½"	153 091 (*)	58 127	0,343 12,12	6			
		L160 w 63"	153 092 (*)	64 141	0,361 12,76	6			
		L180 w 71"	153 093 (*)	70 154	0,374 13,22	6			
BENCH PROF. CM 80+80 bench deep 31½"+31½"  L1 x p.165,2 x H.72,8 L1 x d 65" x h 28¾"	L1		CON GAMBA CENTRALE APERTA <i>with open central leg</i>						
	L240 w 96½"	L120 w 47½"	153 140 (*)	105 237	0,599 21,17	11			
	L280 w 110½"	L140 w 55½"	153 141 (*)	109 240	0,639 22,58	11			
	L320 w 128"	L160 w 63"	153 142 (*)	121 266	0,675 23,85	11			
	L360 w 147½"	L180 w 71"	153 143 (*)	133 293	0,701 24,77	11			
	L1		CON GAMBA CENTRALE WIRE-MANAGER <i>with central wire-manager leg</i>						
	L240 w 96½"	L120 w 47½"	153 145 (*)	108 238	0,599 21,17	11			
	L280 w 110½"	L140 w 55½"	153 146 (*)	112 246	0,639 22,58	11			
	L320 w 128"	L160 w 63"	153 147 (*)	124 273	0,675 23,85	11			
	L360 w 147½"	L180 w 71"	153 148 (*)	136 299	0,701 24,77	11			
BENCH PROF. CM 80+80 bench deep 31½"+31½"  L1 x p.165,2 x H.72,8 L1 x d 65" x h 28¾"	L1		CON GAMBE CENTRALI APERTE <i>with open central legs</i>						
	L360 w 147½"	L120 w 47½"	153 150 (*)	154 339	0,875 30,92	16			
	L420 w 105½"	L140 w 55½"	153 151 (*)	160 352	0,935 32,04	16			
	L480 w 189"	L160 w 63"	153 152 (*)	178 392	0,989 34,95	16			
	L540 w 212½"	L180 w 71"	153 153 (*)	196 432	1,029 36,36	16			
	L1		CON GAMBE CENTRALI WIRE-MANAGER <i>with central wire-manager legs</i>						
	L360 w 147½"	L120 w 47½"	153 155 (*)	160 352	0,875 30,92	16			
	L420 w 105½"	L140 w 55½"	153 156 (*)	166 365	0,935 32,04	16			
	L480 w 189"	L160 w 63"	153 157 (*)	184 405	0,989 34,95	16			
	L540 w 212½"	L180 w 71"	153 158 (*)	202 445	1,029 36,36	16			
SCRIVANIA TERMINALE PER BENCH PROF. CM 80+80 terminal desk for bench deep 31½"+31½"  L. 165,2 x p.80 x H.72,8 w 65" x d 31½" x h 28¾"	L1								
		L165,2 w 65"	153 169 (*)	34 74	0,186 6,57	4			

(*)	PIANO	STRUTTURA	top	structure
017	NOCE HARI	ARGENTO	hart walnut	silver
020	ACERO TAKI	ARGENTO	take maple	silver
027	BIANCO FRASSINO	ARGENTO	ash white	silver
040	BIANCO BR.	ARGENTO	br. white	silver
090	WENGE	ARGENTO	wenge	silver
400	BIANCO BR.	BIANCO	br. white	white
417	NOCE HARI	BIANCO	hart walnut	white
420	ACERO TAKI	BIANCO	take maple	white
427	BIANCO FRASSINO	BIANCO	ash white	white
490	WENGE	BIANCO	wenge	white
517	NOCE HARI	ANTRACITE	hart walnut	anthracite
520	ACERO TAKI	ANTRACITE	take maple	anthracite
527	BIANCO FRASSINO	ANTRACITE	ash white	anthracite
540	BIANCO BR.	ANTRACITE	br. white	anthracite
590	WENGE	ANTRACITE	wenge	anthracite



ATTENZIONE! PER PANNELLI FRONTALI E BARRE ATTREZZABILI VEDI DA PAG 26 A 34
Attention! For front panels and toolbars, please see pages from 26 to 34

5th ELEMENT

BENCH CON PIANI SCORREVOLI (PIANI BORDATI SP. MM 18 MELAMINICO)
bench with sliding worktops (square edged melamine tops thick. 3/4")

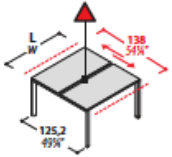
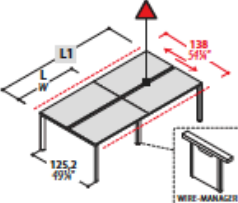
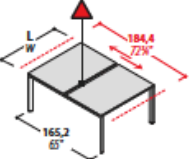
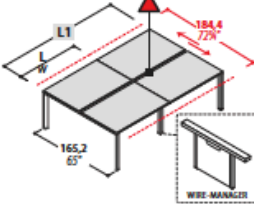
DESCRIZIONE <i>description</i>	L	w	CODICE <i>code</i>	KG <i>lb</i>	M ³ <i>ft³</i>	COLLI <i>pcs</i>	PREZZO <i>price</i>	CODICE FINITURA (*) <i>finish code (*)</i>	
BENCH PROF. CM 60+60 CON PIANI SCORREVOLI <i>bench deep 23" + 23"</i> <i>with sliding worktops</i>  L x p.125,2-138 x H.72,8 <i>width x d 49 1/4"-54" x h 28 3/4"</i>	L1								
		L120 w 47"	153 760 (*)	54 119	0,262 9,43	8			
		L140 w 55"	153 761 (*)	58 127	0,283 10,00	8			
		L160 w 63"	153 762 (*)	64 141	0,298 10,53	8			
		L180 w 71"	153 763 (*)	70 154	0,308 10,88	8			
BENCH PROF. CM 60+60 CON PIANI SCORREVOLI <i>bench deep 23" + 23"</i> <i>with sliding worktops</i>  L1 x p.125,2-138 x H.72,8 <i>L1 x d 49 1/4"-54" x h 28 3/4"</i>	L1		CON GAMBA CENTRALE APERTA <i>with open central leg</i>						
	L240 w 50"	L120 w 47"	153 765 (*)	97 213	0,488 17,24	15			
	L280 w 110"	L140 w 55"	153 766 (*)	105 231	0,521 18,41	15	€		
	L320 w 120"	L160 w 63"	153 767 (*)	117 257	0,551 19,47	15	€		
	L360 w 141"	L180 w 71"	153 768 (*)	129 284	0,571 20,18	15	€		
	L1		CON GAMBA CENTRALE WIRE-MANAGER <i>with central wire-manager leg</i>						
	L240 w 50"	L120 w 47"	153 770 (*)	97 213	0,488 17,24	15	€		
	L280 w 110"	L140 w 55"	153 771 (*)	105 231	0,521 18,41	15	€		
	L320 w 120"	L160 w 63"	153 772 (*)	117 257	0,551 19,47	15	€		
	L360 w 141"	L180 w 71"	153 773 (*)	129 284	0,571 20,18	15	€		
	BENCH PROF. CM 80+80 CON PIANI SCORREVOLI <i>bench deep 31" + 31"</i> <i>with sliding worktops</i>  L x p.165,2-184,4 x H.72,8 <i>width x d 65"-72" x h 28 3/4"</i>	L1							
			L120 w 47"	153 774 (*)	60 132	0,334 11,80	8		
			L140 w 55"	153 775 (*)	62 136	0,354 12,57	8		
		L160 w 63"	153 776 (*)	68 149	0,372 13,14	8			
		L180 w 71"	153 777 (*)	74 163	0,385 13,60	8			
BENCH PROF. CM 80+80 CON PIANI SCORREVOLI <i>bench deep 31" + 31"</i> <i>with sliding worktops</i>  L1 x p.165,2-184,4 x H.72,8 <i>L1 x d 65"-72" x h 28 3/4"</i>	L1		CON GAMBA CENTRALE APERTA <i>with open central leg</i>						
	L240 w 50"	L120 w 47"	153 778 (*)	113 249	0,621 21,94	15	€		
	L280 w 110"	L140 w 55"	153 779 (*)	117 257	0,661 23,36	15	€		
	L320 w 120"	L160 w 63"	153 780 (*)	129 284	0,697 24,63	15	€		
	L360 w 141"	L180 w 71"	153 781 (*)	141 310	0,724 25,58	15	€		
	L1		CON GAMBA CENTRALE WIRE-MANAGER <i>with central wire-manager leg</i>						
	L240 w 50"	L120 w 47"	153 782 (*)	116 255	0,621 21,94	15	€		
	L280 w 110"	L140 w 55"	153 783 (*)	120 264	0,661 23,36	15	€		
	L320 w 120"	L160 w 63"	153 784 (*)	132 291	0,697 24,63	15	€		
	L360 w 141"	L180 w 71"	153 785 (*)	144 317	0,724 25,58	15	€		

(*)	PIANO	STRUTTURA	top	structure
017	NOCE HARI	ARGENTO	hori walnut	silver
020	ACERO TAKI	ARGENTO	taki maple	silver
027	BIANCO FRASSINO	ARGENTO	ash white	silver
040	BIANCO BR.	ARGENTO	br. white	silver
090	WENGÈ	ARGENTO	wangè	silver
400	BIANCO BR.	BIANCO	br. white	white
417	NOCE HARI	BIANCO	hori walnut	white
420	ACERO TAKI	BIANCO	taki maple	white
427	BIANCO FRASSINO	BIANCO	ash white	white
490	WENGÈ	BIANCO	wangè	white
517	NOCE HARI	ANTRACITE	hori walnut	anthracite
520	ACERO TAKI	ANTRACITE	taki maple	anthracite
527	BIANCO FRASSINO	ANTRACITE	ash white	anthracite
540	BIANCO BR.	ANTRACITE	br. white	anthracite
590	WENGÈ	ANTRACITE	wangè	anthracite

SCRIVANIE CON GAMBA A PONTE (PIANI BORDATI SP. MM 18 MELAMINICO)
desks with bridge leg (square edged melamine tops thick. 3/4")

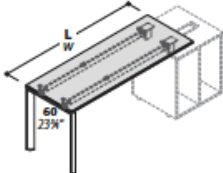
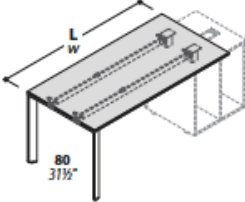
DESCRIZIONE <i>description</i>	L	w	CODICE <i>code</i>	KG <i>lb</i>	M ³ <i>ff³</i>	COLLI <i>pcs</i>	PREZZO <i>price</i>	CODICE FINITURA (*) <i>finish code (*)</i>			
								PIANO	STRUTTURA	top	structure
SCRIVANIE PROF. CM 60 PER PORTA-CPU (CON TRAVI E STAFFE IN DOTAZIONE) <i>desks deep 23 3/4" for CPU-holder (with beams and stirrups)</i>  L x p.60 x H.72,8 <i>width x d 23 3/4" x h 28 3/4"</i>	L120 w 47 1/4"		153 190 (*)	22 48	0,087 3,07	4					
	L140 w 55 1/4"		153 191 (*)	24 52	0,097 3,43	4					
	L160 w 63"		153 192 (*)	27 59	0,105 3,71	4					
	L180 w 71"		153 193 (*)	30 66	0,113 3,99	4					
SCRIVANIE PROF. CM 80 PER PORTA-CPU (CON TRAVI E STAFFE IN DOTAZIONE) <i>desks deep 31 1/2" for CPU-holder (with beams and stirrups)</i>  L x p.80 x H.72,8 <i>width x d 31 1/2" x h 28 3/4"</i>	L120 w 47 1/4"		153 195 (*)	26 57	0,109 3,85	4					
	L140 w 55 1/4"		153 196 (*)	27 59	0,121 4,28	4					
	L160 w 63"		153 197 (*)	30 66	0,131 4,63	4					
	L180 w 71"		153 198 (*)	33 72	0,140 4,95	4					

BENCH CON GAMBA A PONTE (PIANI BORDATI SP. MM 18 MELAMINICO)
bench with bridge leg (square edged melamine tops thick. 3/4")

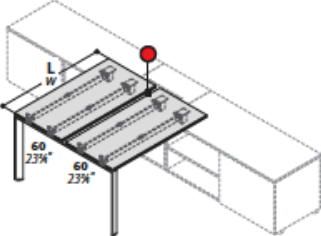
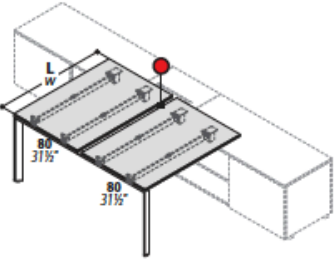
BENCH PROF. CM 60+60 PER PORTA-CPU (CON TRAVI E STAFFE IN DOTAZIONE) <i>bench deep 23 3/4" + 23 3/4" for CPU-holder (with beams and stirrups)</i>  L x p.125,2 x H.72,8 <i>width x d 49 1/4" x h 28 3/4"</i>	L140 w 55 1/4"		153 212 (*)	45 99	0,197 6,96	7					
	L160 w 63"		153 213 (*)	51 112	0,213 7,53	7					
	L180 w 71"		153 214 (*)	57 125	0,228 8,06	7					
	PER COPERTURE CENTRALI , PANNELLI FRONTALI e BARRE ATTREZZABILI VEDI DA PAG.28 A 34 <i>for central covers, front panels and toolbars, please see pages from 28 to 34</i>										
BENCH PROF. CM 80+80 PER PORTA-CPU (CON TRAVI E STAFFE IN DOTAZIONE) <i>bench deep 31 1/2" + 31 1/2" for CPU-holder (with beams and stirrups)</i>  L x p.165,2 x H.72,8 <i>width x d 65" x h 28 3/4"</i>	L140 w 55 1/4"		153 216 (*)	49 108	0,241 8,52	7					
	L160 w 63"		153 217 (*)	55 121	0,261 9,22	7					
	L180 w 71"		153 218 (*)	61 134	0,279 9,86	7					
	PER COPERTURE CENTRALI , PANNELLI FRONTALI e BARRE ATTREZZABILI VEDI DA PAG.28 A 34 <i>for central covers, front panels and toolbars, please see pages from 28 to 34</i>										

(*)	PIANO	STRUTTURA	top	structure
017	NOCE HARI	ARGENTO	hori walnut	silver
020	ACERO TAKI	ARGENTO	taki maple	silver
027	BIANCO FRASSINO	ARGENTO	ash white	silver
040	BIANCO BR.	ARGENTO	br. white	silver
090	WENGE	ARGENTO	wangi	silver
400	BIANCO BR.	BIANCO	br. white	white
417	NOCE HARI	BIANCO	hori walnut	white
420	ACERO TAKI	BIANCO	taki maple	white
427	BIANCO FRASSINO	BIANCO	ash white	white
490	WENGE	BIANCO	wangi	white
517	NOCE HARI	ANTRACITE	hori walnut	anfracto
520	ACERO TAKI	ANTRACITE	taki maple	anfracto
527	BIANCO FRASSINO	ANTRACITE	ash white	anfracto
540	BIANCO BR.	ANTRACITE	br. white	anfracto
590	WENGE	ANTRACITE	wangi	anfracto

(*)	PIANO	STRUTTURA	top	structure
017	NOCE HARI	ARGENTO	hori walnut	silver
020	ACERO TAKI	ARGENTO	taki maple	silver
027	BIANCO FRASSINO	ARGENTO	ash white	silver
040	BIANCO BR.	ARGENTO	br. white	silver
090	WENGE	ARGENTO	wangi	silver
400	BIANCO BR.	BIANCO	br. white	white
417	NOCE HARI	BIANCO	hori walnut	white
420	ACERO TAKI	BIANCO	taki maple	white
427	BIANCO FRASSINO	BIANCO	ash white	white
490	WENGE	BIANCO	wangi	white
517	NOCE HARI	ANTRACITE	hori walnut	anfracto
520	ACERO TAKI	ANTRACITE	taki maple	anfracto
527	BIANCO FRASSINO	ANTRACITE	ash white	anfracto
540	BIANCO BR.	ANTRACITE	br. white	anfracto
590	WENGE	ANTRACITE	wangi	anfracto

ESEMPI DI UTILIZZO SCRIVANIE CON GAMBE A PONTE PER PORTA-CPU (pag.64)
desks with bridge legs for CPU-holder fact-sheet (pages 64)

SCRIVANIE CON PIANI PROF. CM 60-80
 desks with worktops deep 23¾"-31½"

ART.190-191-192-193
 ART.195-196-197-198

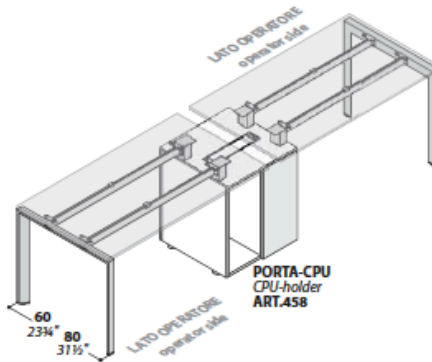
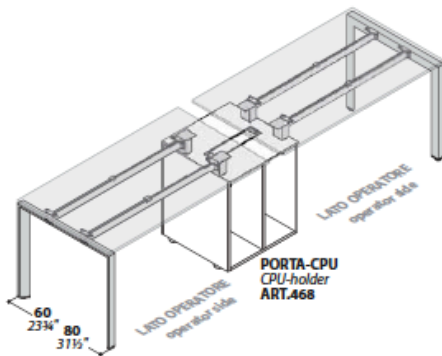
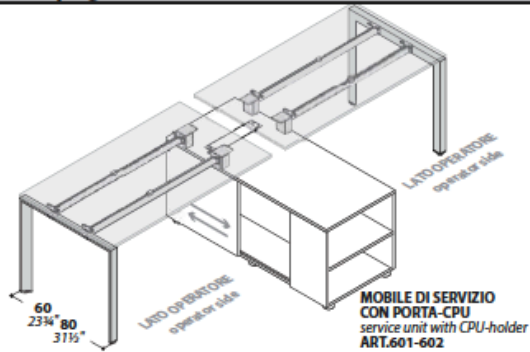
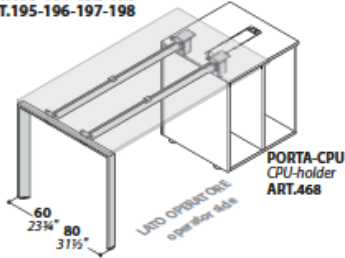

BENCH CON PIANI PROF. CM 60-80
 BENCH with worktops deep 23¾"-31½"
 ART.212-213-214
 ART.216-217-218

COMPLETARE CON STAFFA
 complete with stirrup
 ART.206

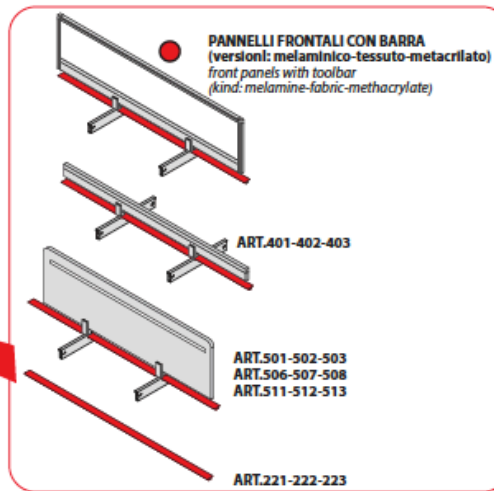
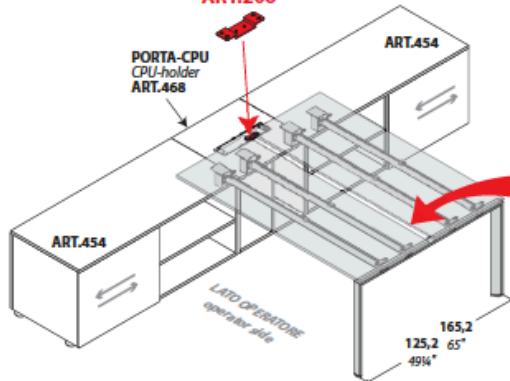

COMPLETARE CON STAFFA
 complete with stirrup
 ART.206

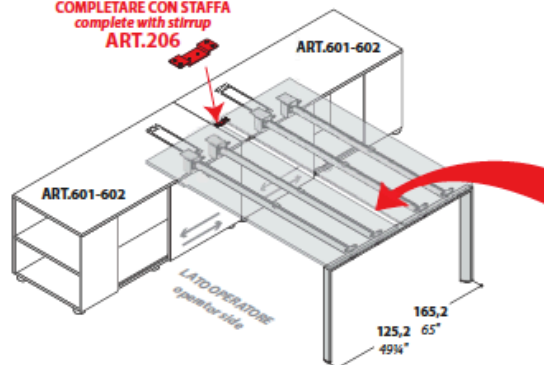

COMPLEMENTI PER BENCH
complements for bench

QUESTI ARTICOLI NON SONO UTILIZZABILI SU SCRIVANIE CON PIANI SCORREVOLI!
don't use these items on desks with sliding tops!

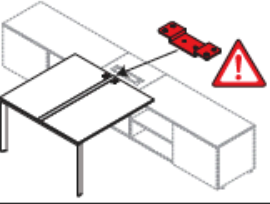
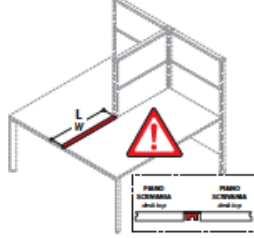
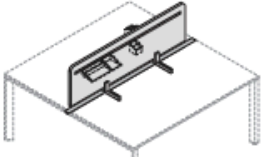
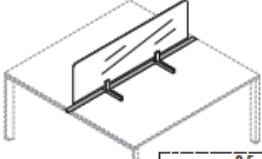
DESCRIZIONE <i>description</i>	L	w	CODICE <i>code</i>	KG <i>lb</i>	M ³ <i>ft³</i>	COLLI <i>pcs</i>	PREZZO <i>price</i>	CODICE FINITURA (*) <i>finish code (*)</i>	
COPERTURA CENTRALE PER BENCH <i>central cover profile for bench</i>  L x p 5,2 x H 1,6 <i>width x d 2" x h 3/4"</i>	L120 w 47 1/2"		153 220 (*)	1 2	0,006 0,21	1			
	L140 w 55 1/2"		153 221 (*)	1 2	0,008 0,28	1			
	L160 w 63"		153 222 (*)	1 2	0,008 0,28	1			
	L180 w 71"		153 223 (*)	1,5 3	0,012 0,42	1			
STAFFA PER COPERTURA CENTRALE <i>stirrup for central cover profile</i> 			153 206 (*)	1,5 3	0,001 0,04	1			
COPERTURA CENTRALE PER BENCH CON PARETINE <i>central cover profile for bench with partition panels</i>  L x p 5,2 x H 1,6 <i>width x d 2" x h 3/4"</i>	L60 w 23 1/2"		153 201 (*)	1,5 3	0,005 0,18	1			
	L70 w 27 1/2"		153 202 (*)	1,5 3	0,007 0,25	1			
	L80 w 31 1/2"		153 203 (*)	1,5 3	0,004 0,14	1			
	L90 w 35 1/2"		153 204 (*)	1,5 3	0,004 0,14	1			
	L100 w 39 1/2"		153 234 (*)	1,5 3	0,007 0,25	1			
	L120 w 47 1/2"		153 239 (*)	1,5 3	0,006 0,21	1			
PANNELLI FRONTALI E COPERTURA CENTRALE PER BENCH <i>front panels and central cover profile for bench</i>  L x p 2,5 x H 35,5 <i>width x d 1" x h 14"</i>			MELAMINICO <i>melamine</i>						
	L120 w 47 1/2"		153 500 (*)	9,5 20	0,036 1,27	3			
	L140 w 55 1/2"		153 501 (*)	10,5 23	0,041 1,45	3			
	L160 w 63"		153 502 (*)	11,5 25	0,042 1,48	3			
	L180 w 71"		153 503 (*)	12,5 27	0,048 1,70	3			
			TESSUTO <i>fabric</i>						
	L120 w 47 1/2"		153 505 (*)	9,5 20	0,036 1,27	3			
	L140 w 55 1/2"		153 506 (*)	10,5 23	0,048 1,70	3			
	L160 w 63"		153 507 (*)	11,5 25	0,048 1,70	3			
	L180 w 71"		153 508 (*)	12,5 27	0,055 1,94	3			
PANNELLI FRONTALI IN METACRILATO E COPERTURA CENTRALE PER BENCH <i>methacrylate front panels and central cover profile for bench</i>  L x p 0,5 x H 35,5 <i>width x d 3/4" x h 14"</i>			METACRILATO <i>methacrylate</i>						
	L120 w 47 1/2"		153 510 (*)	5,5 12	0,016 0,57	3			
	L140 w 55 1/2"		153 511 (*)	6 13	0,019 0,67	3			
	L160 w 63"		153 512 (*)	6 13	0,018 0,64	3			
	L180 w 71"		153 513 (*)	7,5 16	0,023 0,81	3			









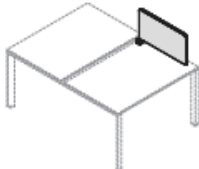

(*)		
000	ARGENTO	silver

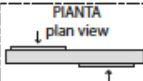
(*)	MELAMINICO	melamine
000	ARGENTO GOLF	golf silver
170	NOCE HARI	hart walnut
200	ACERO TAKI	také maple
270	BIANCO FRASSINO	ash white
400	BIANCO BR.	br. white
550	ANTRACITE	anthracite
900	WENGE'	wenge

(*)	TESSUTO POLIESTERE STRETCH IGNIFUGO	fire-retardant stretch polyester fabric
327	GRIGIO	gray
328	TORTORA	gray beige
329	GIALLO	yellow
330	MATTONE	brick red
331	ARANCIO	orange
332	ROSSO	red
333	VERDE ACIDO	acid green
334	BLU	blue
335	CELESTE	light blue

(*)		
999	METACRILATO BIANCO	white methacrylate

COMPLEMENTI PER BENCH
complements for bench

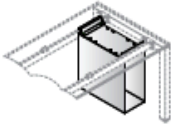
DESCRIZIONE <i>description</i>	L	w	CODICE <i>code</i>	KG	M ³	COLLI <i>pcs</i>	PREZZO <i>price</i>	CODICE FINITURA (*) <i>finish code (*)</i>			
				lb	ft ³						
PANNELLO LATERALE <i>side panel</i>  L. x p.2,5 x H.35,5 <i>width x d 1" x h 14"</i>			MELAMINICO <i>melamine</i>					(*)			
	L.50	w 19"	153 245 (*)	5 11	0,011 0,39	2		000	ARGENTO GOLF	golf silver	
	L.70	w 27"	153 246 (*)	6 13	0,018 0,64	2		170	NOCE HARI	hart walnut	
	L.80	w 31"	153 247 (*)	7 15	0,020 0,71	2		200	ACERO TAKI	taki maple	
			TESSUTO <i>fabric</i>						270	BIANCO FRASSINO	ash white
	L.50	w 19"	153 248 (*)	5 11	0,011 0,39	2		400	BIANCO BR.	br. white	
	L.70	w 27"	153 249 (*)	6 13	0,018 0,64	2		550	ANTRACITE	anthracite	
	L.80	w 31"	153 250 (*)	7 15	0,020 0,71	2		900	WENGE'	wenge	
			METACRILATO <i>methacrylate</i>						(*)		
	L.50	w 19"	153 251 (*)	2 4	0,002 0,07	2		327	GRIGIO	gray	
	L.70	w 27"	153 252 (*)	2,5 5	0,003 0,11	2		328	TORTORA	gray beige	
	L.80	w 31"	153 253 (*)	3 6	0,003 0,11	2		329	GIALLO	yellow	
KIT ELETTRIFICAZIONE BIFACCIALE SU PANNELLI FRONTALI (MELAMINICO O TESSUTO) <i>double-sides electrification kit on front panels</i> <i>(melamine or fabric)</i>  PIANTA <i>plan view</i>  NON DISPONIBILE PER MERCATO U.S.A. <i>not available for US market</i> L.70 x p.7 x H.10 <i>w 27 1/2" x d 2 3/4" x h 4"</i>			153 261 (*)	4,5 9	0,023 0,81	1		(*)			
					PRESE STANDARD ITALIA/GERMANIA E KIT DATI RJ45 <i>Italy/Germany standard sockets and data kit RJ45</i>						
					PRESE STANDARD FRANCIA E KIT DATI RJ45 <i>France standard sockets and data kit RJ45</i>						
					PRESE STANDARD GRAN BRETAGNA E KIT DATI RJ45 <i>Great Britain standard sockets and data kit RJ45</i>						
					PRESE STANDARD ITALIA/GERMANIA E KIT DATI RJ45 <i>Italy/Germany standard sockets and data kit RJ45</i>						
					PRESE STANDARD FRANCIA E KIT DATI RJ45 <i>France standard sockets and data kit RJ45</i>						
					PRESE STANDARD GRAN BRETAGNA E KIT DATI RJ45 <i>Great Britain standard sockets and data kit RJ45</i>						
					PRESE STANDARD ITALIA/GERMANIA E KIT DATI RJ45 <i>Italy/Germany standard sockets and data kit RJ45</i>						
					PRESE STANDARD FRANCIA E KIT DATI RJ45 <i>France standard sockets and data kit RJ45</i>						
					PRESE STANDARD GRAN BRETAGNA E KIT DATI RJ45 <i>Great Britain standard sockets and data kit RJ45</i>						
PORTA-CPU SOSPESO <i>suspended CPU-holder</i>  L.22 x p.50 x H.50 <i>w 8 3/4" x d 19 3/4" x h 19 3/4"</i>			153 264 (*)	5 11	0,006 0,21	1		(*)			
			NON UTILIZZABILE SU PIANI PROF. CM 90 <i>do not usable under desktops deep 35 1/2"</i>								
								000	ARGENTO	silver	
								400	BIANCO	white	
								550	ANTRACITE	anthracite	

BARRE ATTREZZABILI LATERALI A FILO PIANO

lateral desk height toolbars

DESCRIZIONE <i>description</i>	L	w	CODICE <i>code</i>	KG <i>lb</i>	M ³ <i>ft³</i>	COLLI <i>pcs</i>	PREZZO <i>price</i>	CODICE FINITURA (*) <i>finish code (*)</i>
BARRE ATTREZZABILI LATERALI A FILO PIANO <i>lateral desk height toolbars</i> L. x p.2,5 x H.11,6 <i>width x d 1" x h 4½"</i>			(a filo piano scrivania) <i>(desk height)</i>					
	L.125,2	w.47,4"	153 430 (*)	3 6	0,018 0,64	2		
	L.165,2	w.63"	153 431 (*)	3 6	0,018 0,64	2		
BARRA ATTREZZABILE LATERALE A FILO PIANO <i>lateral desk height toolbar</i> L.140 x p.2,5 x H.11,6 <i>w 55¼" x d 1" x h 4½"</i>			(a filo piano scrivania) <i>(desk height)</i>					
	L.140	w.55,4"	153 433 (*)	3 6	0,018 0,64	2		
BARRA ATTREZZABILE LATERALE A FILO PIANO <i>lateral desk height toolbar</i> L.200 x p.2,5 x H.11,6 <i>w 78¼" x d 1" x h 4½"</i>			(a filo piano scrivania) <i>(desk height)</i>					
	L.200	w.78,4"	153 434 (*)	5 11	0,018 0,64	2		
BARRA ATTREZZABILE LATERALE A FILO PIANO <i>lateral desk height toolbar</i> L.280 x p.2,5 x H.11,6 <i>w 110¼" x d 1" x h 4½"</i>			(a filo piano scrivania) <i>(desk height)</i>					
	L.280	w.110,4"	153 435 (*)	3 6	0,018 0,64	2		
BARRA ATTREZZABILE LATERALE A FILO PIANO <i>lateral desk height toolbar</i> L.340 x p.2,5 x H.11,6 <i>w 134" x d 1" x h 4½"</i>			(a filo piano scrivania) <i>(desk height)</i>					
	L.340	w.134"	153 436 (*)	3 6	0,018 0,64	2		
			(*)					
	000	ALLUMINIO	aluminium					

COMPLEMENTI PER BARRE ATTREZZABILI
complements for toolbars

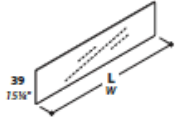
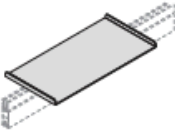
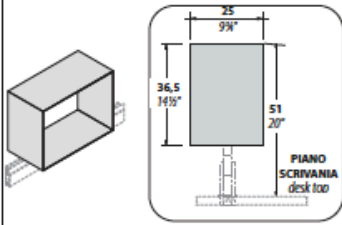
DESCRIZIONE <i>description</i>	L	w	CODICE <i>code</i>	KG	M ³	COLLI <i>pcs</i>	PREZZO <i>price</i>	CODICE FINITURA (*) <i>finish code (*)</i>										
				lb	ft ³													
SCHERMI FRONTALI IN METACRILATO BIANCO PER BARRE ATTREZZABILI LATERALI A FILO PIANO <i>white methacrylate front screens</i> <i>for lateral desk height toolbars</i>  L x p.0,5 x H.39 <i>width x d 1/4" x h 1 5/8"</i>	L.60	w.23"	152 331 (*)	2 4	0,001 0,04	1												
	L.80	w.31"	152 332 (*)	2 4	0,002 0,07	1												
	L.100	w.39"	152 333 (*)	2 4	0,002 0,07	1												
	L.120	w.47"	152 334 (*)	3 6	0,002 0,07	1												
	L.140	w.55"	152 335 (*)	3 6	0,003 0,11	1												
	L.160	w.63"	152 336 (*)	4 8	0,003 0,11	1												
	L.180	w.71"	152 337 (*)	4 8	0,004 0,14	1												
	COMPLETARE SEMPRE CON BARRA ATTREZZABILE A FILO PIANO <i>always complete with desk height toolbar</i>																	
	<table border="1"> <tr> <td>(*)</td> <td>SCHERMO FRONTALE</td> <td>front screen</td> </tr> <tr> <td>999</td> <td>METACRILATO BIANCO</td> <td>white methacrylate</td> </tr> </table>										(*)	SCHERMO FRONTALE	front screen	999	METACRILATO BIANCO	white methacrylate		
(*)	SCHERMO FRONTALE	front screen																
999	METACRILATO BIANCO	white methacrylate																
MENSOLA CENTRALE <i>central shelf</i>  L.50 x p.25 x H.2 <i>w 19 1/4" x d 9 1/4" x h 3/4"</i>	L.50	w.19"	153 450 (*)	5 11	0,016 0,57	1												
	<table border="1"> <tr> <td>(*)</td> <td></td> <td></td> </tr> <tr> <td>000</td> <td>ARGENTO</td> <td>silver</td> </tr> <tr> <td>550</td> <td>ANTRACITE</td> <td>anthracite</td> </tr> </table>										(*)			000	ARGENTO	silver	550	ANTRACITE
(*)																		
000	ARGENTO	silver																
550	ANTRACITE	anthracite																
PORTA-DOX CENTRALE <i>central dox-holder</i>  L.50 x p.25 x H.36,5 <i>w 19 1/4" x d 9 1/4" x h 14 1/2"</i>	L.50	w.19"	153 451 (*)	5 11	0,076 2,69	1												

PANNELLI FRONTALI CON BARRA-ATTEZZABILE PER BENCH (h.38,2 DAL FILO SCRIVANIA)
front panels with toolbar for bench (h.38,2 from worktop)

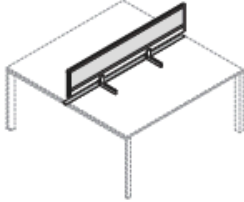
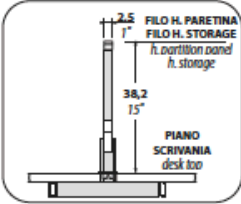
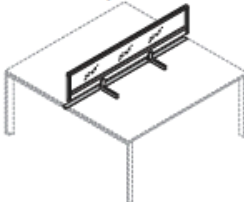
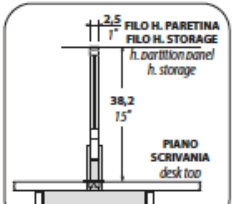
DESCRIZIONE <i>description</i>	L	w	CODICE <i>code</i>	KG	M ³	COLLI <i>pcs</i>	PREZZO <i>price</i>	CODICE FINITURA (*) <i>finish code (*)</i>		
				lb	ft ³					
PANNELLI FRONTALI CON BARRA ATTEZZABILE E COPERTURA CENTRALE PER BENCH <i>front panels with toolbar and central cover profile for bench</i>   L. x p.2,5 x H.38,2 <i>width x d 1" x h 15"</i>			MELAMINICO <i>melamine</i>					(*)	MELAMINICO <i>melamine</i>	
	L120	w 47 1/8"	153 275 (*)	7,5 16	0,042 1,48	3		000	ARGENTO GOLF <i>golf silver</i>	
	L140	w 55 1/8"	153 276 (*)	8,5 18	0,048 1,70	3		170	NOCE HARI <i>hart walnut</i>	
	L160	w 63"	153 277 (*)	9,5 20	0,048 1,70	3		200	ACERO TAKI <i>taki maple</i>	
	L180	w 71"	153 278 (*)	9,5 20	0,055 1,94	3		270	BIANCO FRASSINO <i>ash white</i>	
								400	BIANCO BR. <i>br. white</i>	
								550	ANTRACITE <i>anthracite</i>	
								900	WENGE' <i>wenge</i>	
				TESSUTO <i>fabric</i>					(*)	TESSUTO POLIESTERE STRETCH IGNIFUGO <i>fire-retardant stretch polyester fabric</i>
		L120	w 47 1/8"	153 360 (*)	7,5 16	0,051 1,80	3		327	GRIGIO <i>gray</i>
	L140	w 55 1/8"	153 361 (*)	8,5 18	0,048 1,70	3		328	TORTORA <i>gray beige</i>	
	L160	w 63"	153 362 (*)	9,5 20	0,048 1,70	3		329	GIALLO <i>yellow</i>	
	L180	w 71"	153 363 (*)	9,5 20	0,055 1,94	3		330	MATTONE <i>brick red</i>	
								331	ARANCIO <i>orange</i>	
								332	ROSSO <i>red</i>	
								333	VERDE ACIDO <i>acid green</i>	
								334	BLU <i>blue</i>	
								335	CELESTE <i>light blue</i>	
PANNELLI FRONTALI CON BARRA ATTEZZABILE E COPERTURA CENTRALE PER BENCH <i>front panels with toolbar and central cover profile for bench</i>   L. x p.2,5 x H.38,2 <i>width x d 1" x h 15"</i>			METACRILATO <i>methacrylate</i>					(*)	METACRILATO BIANCO <i>white methacrylate</i>	
	L120	w 47 1/8"	153 366 (*)	5,5 12	0,051 1,80	3		999	METACRILATO BIANCO <i>white methacrylate</i>	
	L140	w 55 1/8"	153 367 (*)	6 13	0,048 1,70	3				
	L160	w 63"	153 368 (*)	6,5 14	0,048 1,70	3				
	L180	w 71"	153 369 (*)	7,5 16	0,055 1,94	3				

PANNELLI FRONTALI CON BARRA-ATTREZZABILE PER BENCH (h.46,7 DAL FILO SCRIVANIA)
front panels (h.46,7 from worktop)

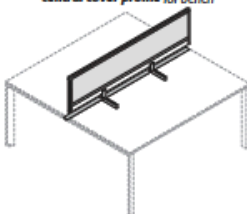
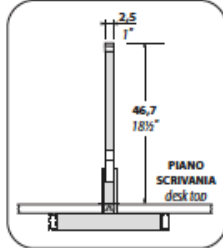
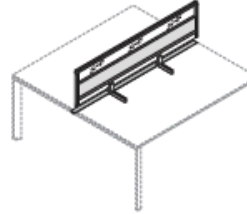
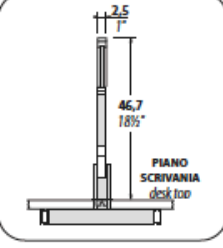
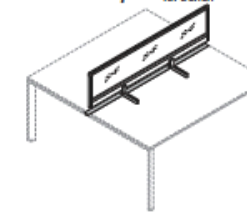
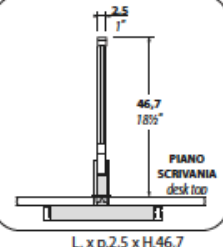
DESCRIZIONE <i>description</i>	L	w	CODICE <i>code</i>	KG <i>lb</i>	M ³ <i>ff³</i>	COLLI <i>pcs</i>	PREZZO <i>price</i>	CODICE FINITURA (*) <i>finish code (*)</i>		
								(*)	MELAMINICO <i>melamine</i>	
PANNELLI FRONTALI CON BARRA ATTREZZABILE E COPERTURA CENTRALE PER BENCH <i>front panels with toolbar and central cover profile for bench</i>   L x p.2,5 x H.46,7 <i>width x d 1" x h 18½"</i>			MELAMINICO <i>melamine</i>					(*)	MELAMINICO <i>melamine</i>	
	L.120 w.47¼"	153 297 (*)	7,5 16	0,042 1,48	3	€ 223,00	000	ARGENTO GOLF	<i>golf silver</i>	
	L.140 w.55¼"	153 298 (*)	8,5 18	0,052 1,84	3	€ 242,00	170	NOCE HARI	<i>hart walnut</i>	
	L.160 w.63"	153 299 (*)	9,5 20	0,057 2,01	3	€ 264,00	200	ACERO TAKI	<i>taki maple</i>	
	L.180 w.71"	153 300 (*)	9,5 20	0,066 2,33	3	€ 303,00	270	BIANCO FRASSINO	<i>ash white</i>	
							400	BIANCO BR.	<i>br. white</i>	
							550	ANTRACITE	<i>antracite</i>	
							900	WENGE'	<i>wenge</i>	
				TESSUTO <i>fabric</i>				(*)	TESSUTO POLIESTERE STRETCH IGNIFUGO	<i>fire-retardant stretch polyester fabric</i>
		L.120 w.47¼"	153 304 (*)	7,5 16	0,051 1,80	3	€ 254,00	327	GRIGIO	<i>gray</i>
	L.140 w.55¼"	153 305 (*)	8,5 18	0,052 1,84	3	€ 272,00	328	TORTORA	<i>gray beige</i>	
	L.160 w.63"	153 306 (*)	9,5 20	0,057 2,01	3	€ 304,00	329	GIALLO	<i>yellow</i>	
	L.180 w.71"	153 307 (*)	9,5 20	0,066 2,33	3	€ 347,00	330	MATTONE	<i>brick red</i>	
PANNELLI FRONTALI CON BARRA ATTREZZABILE E COPERTURA CENTRALE PER BENCH <i>front panels with toolbar and central cover profile for bench</i>   L x p.2,5 x H.46,7 <i>width x d 1" x h 18½"</i>			MELAMINICO + METACRILATO BIANCO <i>melamine + white methacrylate</i>					(*)	MELAMINICO <i>melamine</i>	
	L.120 w.47¼"	153 311 (*)	7,5 16	0,051 1,80	3	€ 276,00	000	ARGENTO GOLF	<i>golf silver</i>	
	L.140 w.55¼"	153 312 (*)	8,5 18	0,052 1,84	3	€ 306,00	170	NOCE HARI	<i>hart walnut</i>	
	L.160 w.63"	153 313 (*)	9,5 20	0,057 2,01	3	€ 349,00	200	ACERO TAKI	<i>taki maple</i>	
	L.180 w.71"	153 314 (*)	9,5 20	0,066 2,33	3	€ 387,00	270	BIANCO FRASSINO	<i>ash white</i>	
							400	BIANCO BR.	<i>br. white</i>	
							550	ANTRACITE	<i>antracite</i>	
							900	WENGE'	<i>wenge</i>	
				TESSUTO + METACRILATO BIANCO <i>fabric + white methacrylate</i>				(*)	TESSUTO POLIESTERE STRETCH IGNIFUGO	<i>fire-retardant stretch polyester fabric</i>
		L.120 w.47¼"	153 318 (*)	7,5 16	0,051 1,80	3	€ 298,00	327	GRIGIO	<i>gray</i>
	L.140 w.55¼"	153 319 (*)	8,5 18	0,052 1,84	3	€ 328,00	328	TORTORA	<i>gray beige</i>	
	L.160 w.63"	153 320 (*)	9,5 20	0,057 2,01	3	€ 375,00	329	GIALLO	<i>yellow</i>	
	L.180 w.71"	153 321 (*)	9,5 20	0,066 2,33	3	€ 418,00	330	MATTONE	<i>brick red</i>	
PANNELLI FRONTALI CON BARRA ATTREZZABILE E COPERTURA CENTRALE PER BENCH <i>front panels with toolbar and central cover profile for bench</i>   L x p.2,5 x H.46,7 <i>width x d 1" x h 18½"</i>			METACRILATO <i>methacrylate</i>					(*)	MELAMINICO <i>melamine</i>	
	L.120 w.47¼"	153 324 (*)	5,5 12	0,051 1,80	3	€ 318,00	000	ARGENTO GOLF	<i>golf silver</i>	
	L.140 w.55¼"	153 325 (*)	6 13	0,052 1,84	3	€ 353,00	170	NOCE HARI	<i>hart walnut</i>	
	L.160 w.63"	153 326 (*)	6,5 14	0,057 2,01	3	€ 408,00	200	ACERO TAKI	<i>taki maple</i>	
	L.180 w.71"	153 327 (*)	7,5 16	0,066 2,33	3	€ 442,00	270	BIANCO FRASSINO	<i>ash white</i>	
							400	BIANCO BR.	<i>br. white</i>	
							550	ANTRACITE	<i>antracite</i>	
							900	WENGE'	<i>wenge</i>	
							999	METACRILATO BIANCO	<i>white methacrylate</i>	

PIANI SCRIVANIE PER GAMBE A PONTE
desktops for bridge legs

DESCRIZIONE <i>description</i>	L	w	CODICE <i>code</i>	KG <i>lb</i>	M ³ <i>ft³</i>	COLLI <i>pcs</i>	PREZZO <i>price</i>	CODICE FINITURA (*) <i>finish code (*)</i>
PIANI SCRIVANIE PROF. CM 60 <i>desktops deep 23¾"</i> L x p.60 x H <i>width x d 23¾" x height</i>			PIANO sp. mm 18 top thick. ¾"					
	L120 w 47½"		153 810 (*)	11 24	0,032 1,13	1		
	L140 w 55½"		153 811 (*)	12 26	0,037 1,31	1		
	L160 w 63"		153 812 (*)	14 30	0,042 1,48	1		
	L180 w 71"		153 813 (*)	16 35	0,047 1,66	1		
			PIANO sp. mm 25 top thick. 1"					
	L120 w 47½"		152 382 (*)	13 28	0,036 1,27	1		
	L140 w 55½"		152 383 (*)	15 32	0,041 1,45	1		
	L160 w 63"		152 384 (*)	17 37	0,047 1,66	1		
	L180 w 71"		152 385 (*)	19 41	0,053 1,87	1		

(*)	PIANI	tops
170	NOCE HARI	hart walnut
200	ACERO TAKI	takl maple
270	BIANCO FRASSINO	ash white
400	BIANCO BR.	br. white
900	WENGE'	wengo

PIANI SCRIVANIE PROF. CM 80 <i>desktops deep 31½"</i> L x p.80 x H <i>width x d 23¾" x height</i>			PIANO sp. mm 18 top thick. ¾"					
	L120 w 47½"		153 815 (*)	14 30	0,042 1,48	1		
	L140 w 55½"		153 816 (*)	14 30	0,044 1,70	1		
	L160 w 63"		153 817 (*)	16 35	0,055 1,94	1		
	L180 w 71"		153 818 (*)	18 39	0,062 2,19	1		
			PIANO sp. mm 25 top thick. 1"					
	L120 w 47½"		152 392 (*)	17 37	0,052 1,84	1		
	L140 w 55½"		152 393 (*)	20 44	0,060 2,12	1		
	L160 w 63"		152 394 (*)	23 50	0,069 2,44	1		
	L180 w 71"		152 395 (*)	26 57	0,077 2,72	1		

PIANI TERMINALI PER BENCH
terminal tops for bench

PIANO TERMINALE PER BENCH PROF. CM 60+60 <i>terminal desktop for bench deep 23¾" + 23¾"</i> L125,2 x p.60 x H <i>w 49¼" x d 23¾" x height</i>			PIANO sp. mm 18 top thick. ¾"					
	L125,2 w 47½"		153 828 (*)	11 24	0,037 1,31	1		
		PIANO sp. mm 25 top thick. 1"						
L125,2 w 47½"		152 414 (*)	13 28	0,037 1,31	1			
PIANO TERMINALE PER BENCH PROF. CM 80+80 <i>terminal desktop for bench deep 31½" + 31½"</i> L165,2 x p.80 x H <i>w 65" x d 31½" x height</i>			PIANO sp. mm 18 top thick. ¾"					
	L165,2 w 63"		153 829 (*)	16 35	0,064 2,28	1		
		PIANO sp. mm 25 top thick. 1"						
L165,2 w 63"		152 415 (*)	23 50	0,064 2,28	1			

(*)	PIANI	tops
170	NOCE HARI	hart walnut
200	ACERO TAKI	takl maple
270	BIANCO FRASSINO	ash white
400	BIANCO BR.	br. white
900	WENGE'	wengo

GAMBE METALLICHE A PONTE CON ALTEZZA REGOLABILE
bridge metal legs with adjustable height

GAMBE TERMINALI CON ALTEZZA REGOLABILE PER SCRIVANIE O BENCH SINGOLI <i>terminal legs with adjustable height for single desk or single bench</i> MIN H.62,4 ÷ MAX H.82,4 <i>min h 24½" ÷ max h 32½"</i>	p.60 d 23¾"	153 740 (*)	7 15	0,037 1,31	1		
	p.80 d 31½"	153 741 (*)	8 17	0,049 1,73	1		
	p.125 d 49½"	153 743 (*)	11 24	0,077 2,72	1		
	p.165 d 65"	153 744 (*)	11 24	0,098 3,46	1		
	ELEMENTO TELESCOPICO INTERNO SEMPRE COLORE ARGENTO <i>inside telescopic element is always in silver colour</i>						

(*)		
000	ARGENTO	silver
400	BIANCO	white
550	ANTRACITE	anthracite

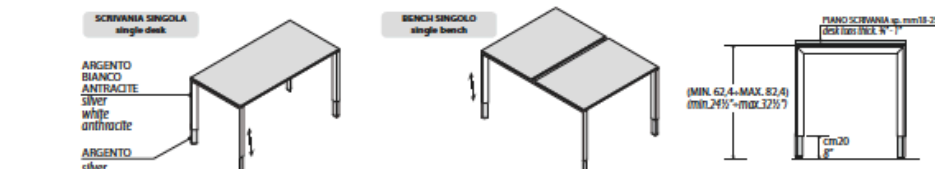

GAMBE METALLICHE A PONTE
bridge metal legs

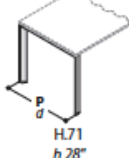
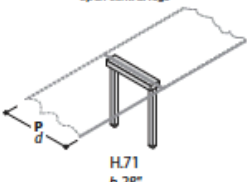
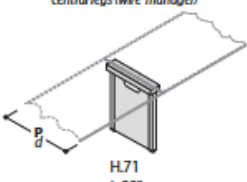
DESCRIZIONE <i>description</i>	P	d	CODICE <i>code</i>	KG	M ³	COLLI <i>pcs</i>	PREZZO <i>price</i>	CODICE FINITURA (*)	
				lb	ft ³			<i>finish code</i> (*)	
GAMBE TERMINALI <i>terminal legs</i> 	p.60	d.239*	153 700 (*)	7 15	0,037 1,31	1			
	p.80	d.311*	153 701 (*)	8 17	0,049 1,73	1			
	p.125	d.491*	153 702 (*)	11 24	0,077 2,72	1			
	p.165	d.65*	153 703 (*)	11 24	0,098 3,46	1			
GAMBE CENTRALI APERTE <i>open central legs</i> 	p.80	d.311*	153 707 (*)	7 15	0,062 2,19	1			(*)
	p.125	d.491*	153 708 (*)	11 24	0,108 3,82	1			000 ARGENTO silver
	p.165	d.65*	153 709 (*)	15 33	0,149 5,27	1			400 BIANCO white
GAMBE CENTRALI (WIRE-MANAGER) <i>central legs (wire-manager)</i> 	WIRE-MANAGER								
	p.80	d.311*	153 711 (*)	11 24	0,062 2,19	1			550 ANTRACITE anfracto
	p.125	d.491*	153 712 (*)	11 24	0,108 3,82	1			
p.165	d.65*	153 713 (*)	18 39	0,149 5,27	1				

GAMBE METALLICHE A PONTE TERMINALI DA APPOGGIO
short terminal bridge metal legs

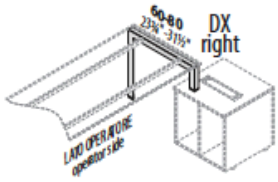
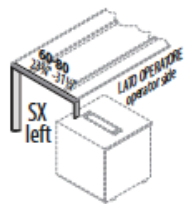
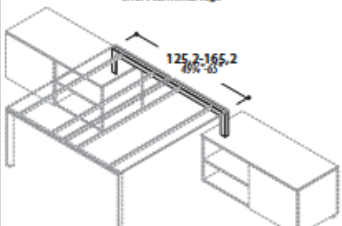
GAMBE TERMINALI DX DA APPOGGIO <i>right short terminal legs</i> 			NOVITA' <i>new</i>									
					DX right	p.60	d.239*	153 801 (*)	6 13	0,037 1,31	1	
					p.80	d.311*	153 803 (*)	7 15	0,049 1,73	1		
DA UTILIZZARE IN APPOGGIO SU MOBILI DI SERVIZIO O PORTA CPU (VEDI PAG.63-64) <i>put on service units or cpu-holder (please, you see pages 63-64)</i>												
GAMBE TERMINALI SX DA APPOGGIO <i>left short terminal legs</i> 			NOVITA' <i>new</i>									
					SX left	p.60	d.239*	153 802 (*)	6 13	0,037 1,31	1	
					p.80	d.311*	153 804 (*)	7 15	0,049 1,73	1		
DA UTILIZZARE IN APPOGGIO SU MOBILI DI SERVIZIO O PORTA CPU (VEDI PAG.63-64) <i>put on service units or cpu-holder (please, you see pages 63-64)</i>												
GAMBE TERMINALI DA APPOGGIO <i>short terminal legs</i> 			NOVITA' <i>new</i>									
						p.125	d.491*	153 805 (*)	9 20	0,077 2,72	1	
					p.165	d.65*	153 806 (*)	10 22	0,098 3,46	1		
DA UTILIZZARE IN APPOGGIO SU MOBILI DI SERVIZIO O PORTA CPU (VEDI PAG.63-64) <i>put on service units or cpu-holder (please, you see pages 63-64)</i>												
H.71 h.28"												

TRAVI DI SUPPORTO
support beams

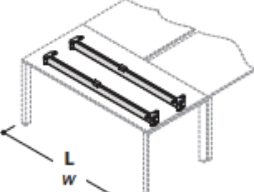
DESCRIZIONE <i>description</i>	L	W	CODICE <i>code</i>	KG	M ³	COLLI <i>pcs</i>	PREZZO <i>price</i>	CODICE FINITURA (**) <i>finish code (**)</i>
				lb	ft ³			
COPPIA DI TRAVI PER GAMBE A PONTE <i>set of 2 beams for bridge legs</i> 	PER PIANI for desktops							
	L100 w 291"		153 720 (*)	2 4	0,016 0,57	1		
	L120 w 471"		153 721 (*)	3 6	0,021 0,74	1		
	L140 w 551"		153 722 (*)	4 8	0,024 0,85	1		
	L160 w 63"		153 723 (*)	5 11	0,027 0,95	1		
	L180 w 71"		153 724 (*)	6 13	0,027 0,95	1		
PER UTILIZZO VEDI SCHEMA PAGINA SEGUENTE <i>for use see scheme to next page</i>								
								(*)
								000 ARGENTO silver
COPPIA DI TRAVI PER SCRIVANIE TERMINALI CON GAMBE A PONTE <i>set of 2 beams for terminal desks with bridge legs</i> 	PER PIANI for desktops							
	L125,2 w 471"		153 733 (*)	2 4	0,021 0,74	1		
	L165,2 w 65"		153 734 (*)	4 8	0,022 0,78	1		

VASCHETTE CENTRALI PASSA-CAVI PER BENCH E SCRIVANIE SINGOLE
central cable trays for bench and single desks

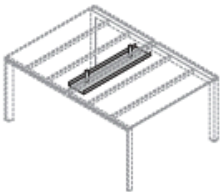
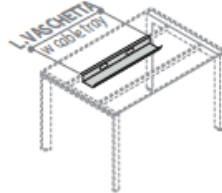
DESCRIZIONE <i>description</i>	L	W	CODICE <i>code</i>	KG	M ³	COLLI <i>pcs</i>	PREZZO <i>price</i>	CODICE FINITURA (**) <i>finish code (**)</i>	
				lb	ft ³				
VASCHETTE CENTRALI PASSACAVI PER BENCH <i>central cable trays for bench</i> 	L90 w 251"		153 240 (*)	1,5 3	0,013 0,46	1			
	L121 w 471"		153 242 (*)	1,5 3	0,022 0,78	1			
	PER UTILIZZO VEDI SCHEMA PAGINA SEGUENTE <i>for use see scheme to next page</i>								
ABBINAMENTO A: For combining with:			COMPLETARE SEMPRE CON: always complete with:						
A) BENCH bench			COPERTURA DA ART.200 A ART.223 (PAG.28) <i>cover from art.200 to art.223 (page 28)</i> PANNELLO FRONTALE + COPERTURA DA ART.500 A ART.513 (PAG.28) <i>front panel + cover from art.500 to art.513 (page 28)</i> BARRA ATTREZZABILE + COPERTURA DA ART.400 A ART.403 (PAG.30) <i>toolbars cover from art.400 to art.403 (page 30)</i> PANNELLO FRONTALE CON BARRA ATTREZZABILE + COPERTURA DA ART.275 A ART.269 (PAG.33-34) <i>front panel + cover from art.275 to art.269 (page 33-34)</i>						
L. x p.20 x H.10 width x d 8" x h 4"									
								(*)	
								000 ARGENTO silver	
VASCHETTA PASSACAVI PER SCRIVANIE SINGOLE <i>cable tray for single desk</i> 	L. VASCHETTA w cable tray	PER TRAVI for beams							
	L50 w 171"	L80 w 211"	152 681 (*)	1 2	0,014 0,49	1			
	L70 w 271"	L100 w 291"	152 682 (*)	1,5 3	0,014 0,49	1			
	L90 w 351"	L120 w 471"	152 683 (*)	1,5 3	0,015 0,53	1			
	L110 w 431"	L140 w 551"	152 684 (*)	2 4	0,015 0,53	1			
	L130 w 511"	L160 w 63"	152 685 (*)	2 4	0,021 0,74	1			
	L150 w 59"	L180 w 71"	152 686 (*)	2 4	0,021 0,74	1			
	L170 w 67"	L200 w 791"	152 687 (*)	2,5 5	0,027 0,95	1			
	L190 w 74 1/2"	L220 w 861"	152 688 (*)	2,5 5	0,027 0,95	1			
	PER UTILIZZO VEDI SCHEMA PAGINA SEGUENTE <i>for use see scheme to next page</i>								

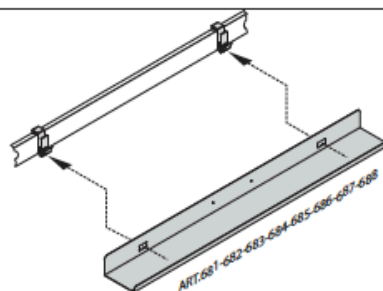

SCHEMA DI UTILIZZO TRAVI E VASCHETTA PORTA-CAVI
 scheme of using support beams and cable-tray

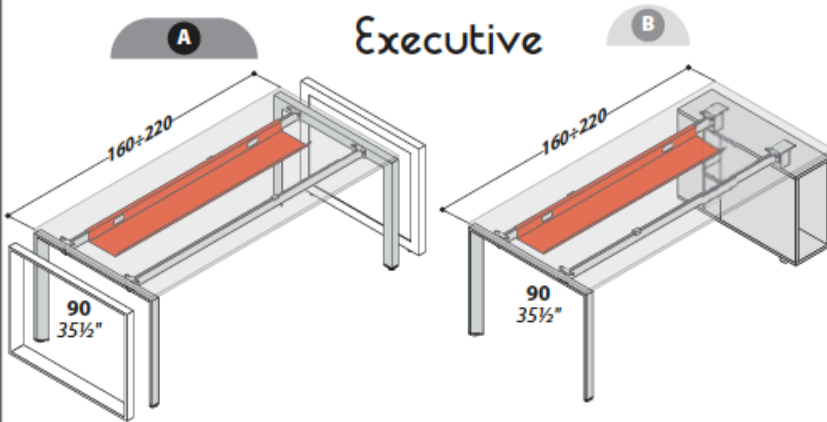

	PIANO desk top	VASCETTA PORTA-CAVI cable tray
A	L.160 w.63"	ART. 685
	L.180 w.71"	ART. 686
	L.200 w.78 1/2"	ART. 687
	L.220 w.86 1/2"	ART. 688
B	L.160 w.63"	ART. 684
	L.180 w.71"	ART. 685
	L.200 w.78 1/2"	ART. 686
	L.220 w.86 1/2"	ART. 687

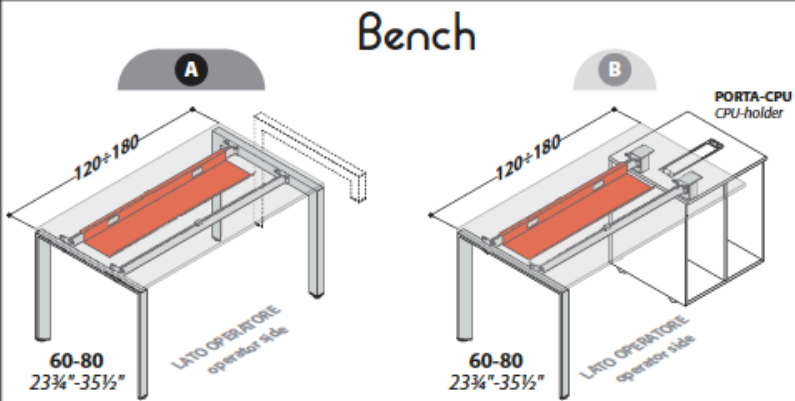

	PIANO desk top	TRAVI beams	VASCETTA PORTA-CAVI cable tray
A	L.120 w.47 1/8"	ART. 721	ART. 683
	L.140 w.55 1/8"	ART. 722	ART. 684
	L.160 w.63"	ART. 723	ART. 685
	L.180 w.71"	ART. 724	ART. 686
B	L.120 w.47 1/8"	ART. 720	ART. 682
	L.140 w.55 1/8"	ART. 721	ART. 683
	L.160 w.63"	ART. 722	ART. 684
	L.180 w.71"	ART. 723	ART. 685

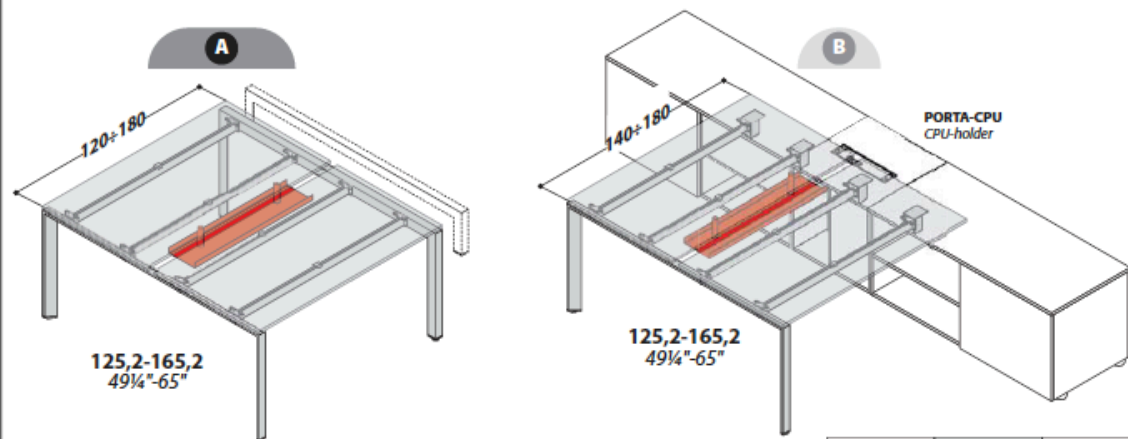

	PIANO desk top	TRAVI beams	VASCETTA CENTRALE PORTA-CAVI central cable tray
A	L.120 w.47 1/8"	ART. 721	ART. 240
	L.140 w.55 1/8"	ART. 722	ART. 242
	L.160 w.63"	ART. 723	ART. 242
	L.180 w.71"	ART. 724	ART. 242
B	L.140 w.55 1/8"	ART. 721	ART. 240
	L.160 w.63"	ART. 722	ART. 240
	L.180 w.71"	ART. 723	ART. 242

STAFFE
stirrups

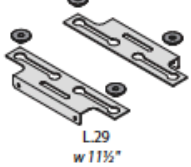
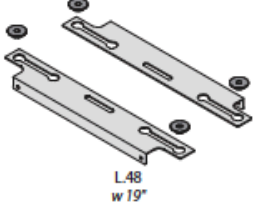
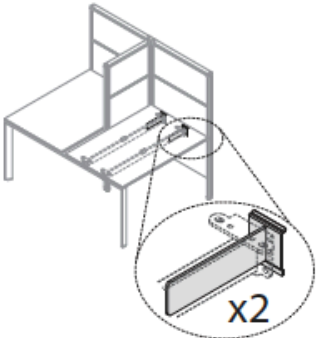
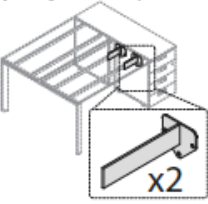
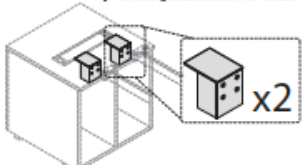
DESCRIZIONE <i>description</i>	P	d	CODICE <i>code</i>	KG <i>lb</i>	M ³ <i>ft³</i>	COLLI <i>pcs</i>	PREZZO <i>price</i>	CODICE FINITURA (*) <i>finish code (*)</i>
KIT 2 STAFFE PER 1 PIANO SCORREVOLE PROF. CM 60 kit 2 stirrups for 1 sliding desktop deep 23 3/4"  L.29 w 11 1/2"			PROF. CM 60 deep 23 3/4" 153 748 (*)	2/4	0,003/0,11	1		
<i>RISAGGIO SU 2 GAMBE A PONTE</i> fixing with 2 bridge legs								
KIT 2 STAFFE PER 1 PIANO SCORREVOLE PROF. CM 80-90 kit 2 stirrups for 1 sliding desktop deep 31 1/2"-35 1/2"  L.48 w 19"			PROF. CM 80-90 deep 31 1/2"-35 1/2" 153 749 (*)	2/4	0,005/0,18	1		
<i>RISAGGIO SU 2 GAMBE A PONTE</i> fixing with 2 bridge legs								
KIT 2 STAFFE PER ATTACCO TRAVI A PARETINA kit 2 stirrups for connection with to partition panels  x2			153 718 (*)	2/4	0,006/0,21	1		
KIT 2 STAFFE PER ATTACCO TRAVI SU CASSETTIERE LATERALIO MOBILI LATERALI kit 2 stirrups for fixing beams with lateral pedestals or lateral cabinets  x2			153 728 (*)	2/4	0,006/0,21	1		
KIT 2 STAFFE PER ATTACCO TRAVI SU PORTA-CPU kit 2 stirrups for fixing beams with CPU-holder  x2			153 725 (*)	2/4	0,001/0,04	1		

(*)		
000	ARGENTO	silver



ATTENZIONE!
 UTILIZZARE TRAVI CON LUNGHEZZA INFERIORE DI 20 CM RISPETTO AL PIANO
 ESEMPIO: CON PIANO L.160 UTILIZZARE TRAVI L.140

warning!
 use 8" shorter beam respect the top
 example: with w 63" top use w 55 1/4" beams

