

ESPLOSO COMPONENTI

components

PIANI IN LEGNO O CRISTALLO:

Disponibili in due tipologie:

A) - Piani in legno : realizzati con pannelli in MDF sp. 30 mm rivestiti con foglia polimerica (PVC), con angoli smussati. Sono disponibili nei colori: WENGE 45, NOCE 57, ACERO TAKI 58, BIANCO BR. 69, LARICE SABBIA 85, LARICE MOKA 86.

B) - Piani in Cristallo : realizzati in lastra temperata di sp. 12 mm retro-laccati a filo lucido con angoli smussati.

Il fissaggio alla struttura avviene tramite placche di acciaio incollate sul lato interno del piano stesso

Sono disponibili nei colori: NERO 10, VANIGLIA 73, ROSSO RUBINO 74, PISTACCHIO 75.

WOODEN OR CRYSTAL SURFACES:

Available in two types:

A) - Wood surfaces : made with MDF panels 30 mm thick covered in polymeric leaf (PVC), with smooth angles. Available in the following colours: WENGE 45, WALNUT 57, TAKI MAPLE 58, BR. WHITE 69, SAND LARCH 85, MOKA LARCH 86.

B) - Crystal surfaces : made in tempered plate 12 mm thick polished wire rear-lacquered with smooth angles. The structure is fixed with two steel brackets stuck on the inside of the surface Available in the following colours: BLACK 10, VANILLA 73, RUBY RED 74, PISTACHIO 75.

INSERTO CENTRALE IN LEGNO

Realizzato con pannelli in MDF sp. 30 mm rivestiti con foglia polimerica (PVC), con angoli smussati. E' disponibile nei colori: WENGE 45, NOCE 57, ACERO TAKI 58, BIANCO BR. 69, LARICE SABBIA 85, LARICE MOKA 86.

WOODEN CENTRAL TOP:

Made with MDF panels 30 mm thick covered in polymeric leaf (PVC), with smooth angles. Available in the following colours: WENGE 45, WALNUT 57, TAKI MAPLE 58, BR. WHITE 69, SAND LARCH 85, MOKA LARCH 86.

TOP ACCESS

Realizzato in alluminio estruso anodizzato effetto cromo lucido satinato, dotato di sportellino con apertura a ribalta per l'accesso al sottostante vano wire management oltre all'apertura passacavi lineare con spazzolino parapolvere nero.

TOP ACCESS

Made in anodised extruded aluminium with satin polished chrome effect, equipped with flap opening door to access wire management bay underneath as well as the linear cable path opening with black dust seal brush.

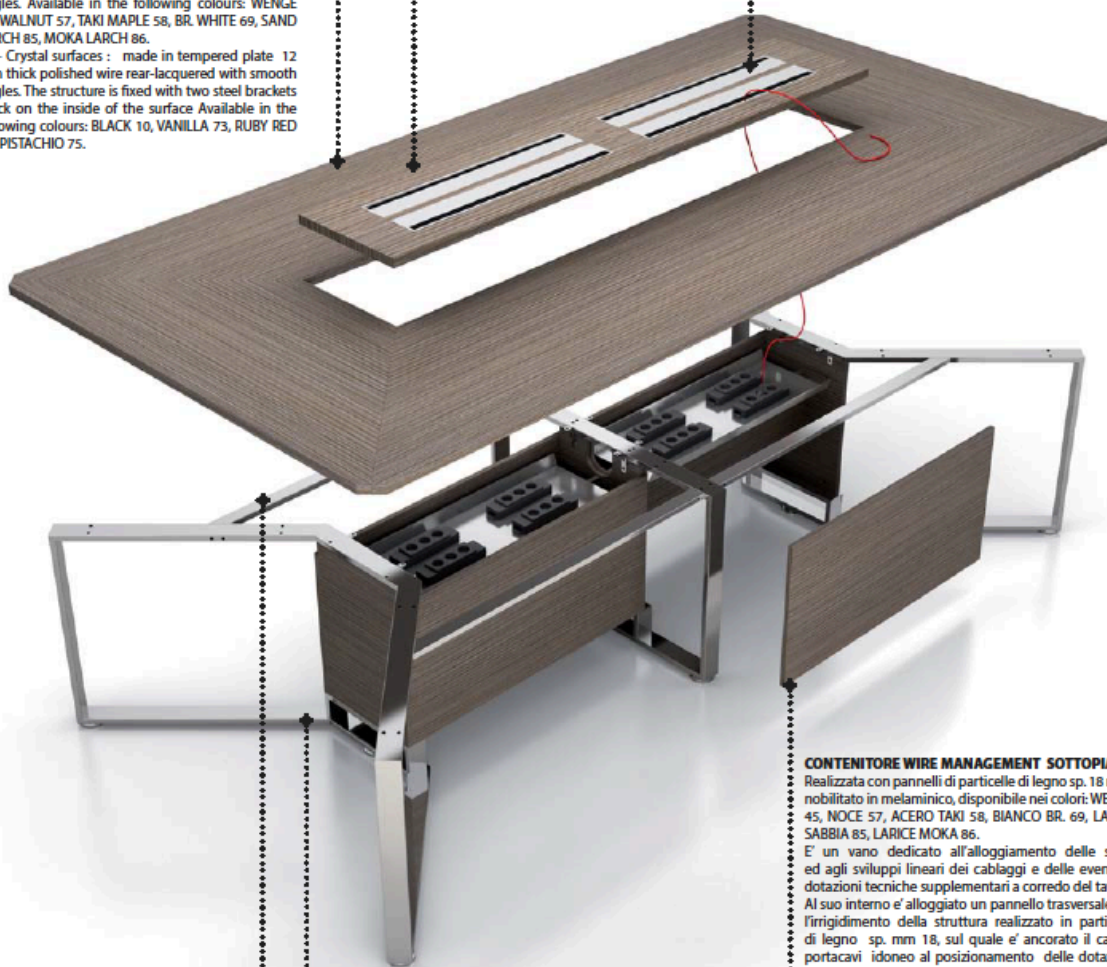

STRUTTURA METALLICA ORIZZONTALE

Struttura costituita da travi di irrigidimento in tubolare sez. 50x20mm verniciate a polveri epossidiche nel colore ARGENTO METALLIZZATO.

La struttura e' pre-forata per il fissaggio delle viti dei piani.

Il montaggio con le gambe basamento avviene con connessioni metalliche rapide dotate di viti coniche.

HORIZONTAL METAL STRUCTURE

Structure made with stiffening beams in 50x20mm tubular painted with METALLIZED SILVER epoxy dust. The structure is pre-perforated for fixing the surface screws. The base legs assembling is carried out with fast metal connections equipped with taper screws.

GAMBE BASAMENTO METALLICO :

Realizzate con tubolare di acciaio sez. 70x20mm, disponibili in due versioni

A) - Verniciate a polveri epossidiche ARGENTO METALLIZZATO.

B) - Cromato lucido

Piedini regolabili diametro 60 mm finitura Cromo.

Le gambe terminali e centrali, sono combinabili fra loro e consentono l'aggregazione di vari moduli idonei a configurare molteplici tipologie di tavoli di forma quadrata o rettangolare che ne consentono l'utilizzo in sale di piccola e media riunione così come per grandi sale consigliari.

METAL BASE LEGS :

Made with 70x20mm steel tubular, available in two versions

A) - METALLIZED SILVER epoxy dust painted.

B) - Chrome polished

60 mm diameter adjustable feet Chrome finishing.

The end and middle legs are compatible between them and enable the aggregation of various modules suitable for the configuration of multiple types of round or rectangular tables used for small and medium meeting rooms as well as board rooms.

CONTENITORE WIRE MANAGEMENT SOTTOPIANO

Realizzata con pannelli di particelle di legno sp. 18 mm, nobilitato in melaminico, disponibile nei colori: WENGE 45, NOCE 57, ACERO TAKI 58, BIANCO BR. 69, LARICE SABBIA 85, LARICE MOKA 86.

E' un vano dedicato all'alloggiamento delle salite ed agli sviluppi lineari dei cablaggi e delle eventuali dotazioni tecniche supplementari a corredo del tavolo.

Al suo interno e' alloggiato un pannello trasversale per l'irrigidimento della struttura realizzato in particelle di legno sp. mm 18, sul quale e' ancorato il canale portacavi idoneo al posizionamento delle dotazioni tecniche (prese schuko, prese fonia e dati) oltre alle eccedenze dei cavi.

Al contenitore Wire management si accede direttamente dal piano di lavoro tramite il top access oppure lateralmente al contenitore stesso tramite l'apertura a scatto del pannello.

SUBSTAGE WIRE MANAGEMENT CONTAINER

Made with 18 mm wooden particles panels, melamine enobled, available in the following colours: WENGE 45, WALNUT 57, TAKI MAPLE 58, BR. WHITE 69, SAND LARCH 85, MOKA LARCH 86. It is a bay for housing the climbings and the cable linear developments and any table supplementary technical equipment kit.

Inside is a transversal panel for stiffening the structure made of 18 mm thick wooden particles, on which the cable holder is anchored, ideal for positioning the technical equipment (schuko sockets, speech and data sockets) as well as excess cables.

Access to the Wire management container is gained directly from the work surface through the top access Or at the side of the container, through the panel trigger opening.

TAVOLI RIUNIONE PROF. CM 120 CON PIANI IN LEGNO
meeting tables deep 47¼" with wooden tops

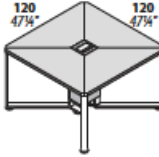
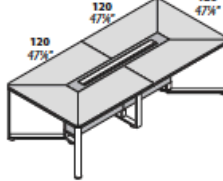
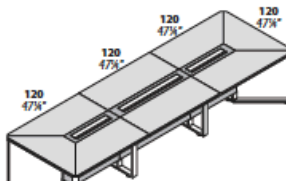
DESCRIZIONE <i>description</i>	L	w	CODICE <i>code</i>	KG	M ³	COLLI	PREZZO	CODICE FINITURA (*) <i>finish code (*)</i>
				lb	ft ³	pcs	price	
TAVOLO RIUNIONE QUADRATO L.120x120 <i>squared meeting table w 47¼"x47¼"</i>  L.120 x p.120 x H.75 <i>w 47¼" x d 47¼" x h 29½"</i>	L.120	w 47¼"	GAMBE VERNICIATE <i>painte legs</i>	81	0,306	12		
			146 514 (*)	178	10,81			
	L.120	w 47¼"	GAMBE CROMATE <i>chromed legs</i>	81	0,306	12		
			146 614 (*)	178	10,81			
TAVOLO RIUNIONE RETTANGOLARE L.240x120 <i>rectangular meeting table w 94½"x47¼"</i>  L.240 x p.120 x H.75 <i>w 94½" x d 47¼" x h 29½"</i>	L.240	w 94½"	GAMBE VERNICIATE <i>painte legs</i>	142	0,565	20		
			146 544 (*)	313	19,96			
	L.240	w 94½"	GAMBE CROMATE <i>chromed legs</i>	142	0,565	20		
			146 644 (*)	313	19,96			
TAVOLO RIUNIONE RETTANGOLARE L.360x120 <i>rectangular meeting table w 141¾"x47¼"</i>  L.360 x p.120 x H.75 <i>w 141¾" x d 47¼" x h 29½"</i>	L.360	w 141¾"	GAMBE VERNICIATE <i>painte legs</i>	212	0,926	29		
			146 567 (*)	467	32,72			
	L.360	w 141¾"	GAMBE CROMATE <i>chromed legs</i>	212	0,926	29		
			146 667 (*)	467	32,72			

(*)	CONTENITORE WIRE MANAGEMENT E INSERITO CENTRALE		top	wire management container and central top
	PIANO	NOCE	NOCE	walnut
100	NOCE	NOCE	walnut	walnut
200	ACERO TAKI	ACERO TAKI	taki maple	taki maple
240	BIANCO BR.	ACERO TAKI	br. white	taki maple
400	BIANCO BR.	BIANCO BR.	br. white	br. white
420	ACERO TAKI	BIANCO BR.	taki maple	br. white
470	LARICE MOKA	BIANCO BR.	moka larch	br. white
490	WENGÉ	BIANCO BR.	wengé	br. white
700	LARICE MOKA	LARICE MOKA	moka larch	moka larch
740	BIANCO BR.	LARICE MOKA	br. white	moka larch
800	LARICE SABBIA	LARICE SABBIA	sand larch	sand larch
840	BIANCO BR.	LARICE SABBIA	br. white	sand larch
870	LARICE MOKA	LARICE SABBIA	moka larch	sand larch
900	WENGÉ	WENGÉ	wengé	wengé
940	BIANCO BR.	WENGÉ	br. white	wengé

ELEMENTI COMPONENTI PER TAVOLI RIUNIONE PROF. CM 120 CON PIANI IN LEGNO
modular elements for meeting tables deep 47¼" with wooden tops

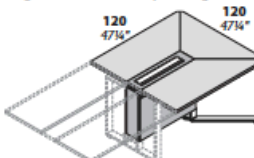
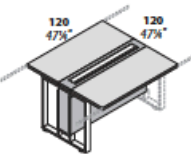
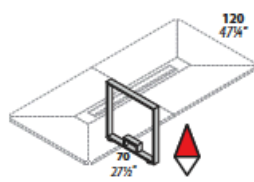
DESCRIZIONE <i>description</i>	L	w	CODICE <i>code</i>	KG	M ³	COLLI	PREZZO	CODICE FINITURA (*) <i>finish code (*)</i>
				lb	ft ³	pcs	price	
MODULO TERMINALE SINGOLO PROF. CM 120 (DX o SX) <i>single terminal module deep 47¼" (right or left)</i>  L.120 x p.120 x H.75 <i>w 47¼" x d 47¼" x h 29½"</i>	L.120	w 47¼"	GAMBE VERNICIATE <i>painte legs</i>	69,5	0,251	10		
			146 583 (*)	153	8,87			
	L.120	w 47¼"	GAMBE CROMATE <i>chromed legs</i>	69,5	0,251	10		
			146 683 (*)	153	8,87			
MODULO CENTRALE PROF. CM 120 <i>central module deep 47¼"</i>  L.120 x p.120 x H.75 <i>w 47¼" x d 47¼" x h 29½"</i>	L.120	w 47¼"	GAMBE VERNICIATE <i>painte legs</i>	67	0,354	8		
			146 584 (*)	147	12,51			
	L.120	w 47¼"	GAMBE CROMATE <i>chromed legs</i>	67	0,354	8		
			146 684 (*)	147	12,51			
GAMBA CENTRALE PER PIANI PROF. CM 120 <i>central leg for tops deep 47¼"</i>  L.7 x p.70 x H.72 <i>w 2¾" x d 27½" x h 28¼"</i>	L.7	p.70	GAMBE VERNICIATE <i>painte legs</i>	6	0,069	1		
			146 587 (*)	13	2,44			
	L.7	p.70	GAMBE CROMATE <i>chromed legs</i>	6	0,069	1		
			146 687 (*)	13	2,44			

(*)	CONTENITORE WIRE MANAGEMENT E INSERITO CENTRALE		top	wire management container and central top
	PIANO	NOCE	NOCE	walnut
100	NOCE	NOCE	walnut	walnut
200	ACERO TAKI	ACERO TAKI	taki maple	taki maple
240	BIANCO BR.	ACERO TAKI	br. white	taki maple
400	BIANCO BR.	BIANCO BR.	br. white	br. white
420	ACERO TAKI	BIANCO BR.	taki maple	br. white
470	LARICE MOKA	BIANCO BR.	moka larch	br. white
490	WENGÉ	BIANCO BR.	wengé	br. white
700	LARICE MOKA	LARICE MOKA	moka larch	moka larch
740	BIANCO BR.	LARICE MOKA	br. white	moka larch
800	LARICE SABBIA	LARICE SABBIA	sand larch	sand larch
840	BIANCO BR.	LARICE SABBIA	br. white	sand larch
870	LARICE MOKA	LARICE SABBIA	moka larch	sand larch
900	WENGÉ	WENGÉ	wengé	wengé
940	BIANCO BR.	WENGÉ	br. white	wengé

(*)	GAMBA		leg
	ARGENTO METALLIZZATO	metallic silver	leg
300	ARGENTO METALLIZZATO	metallic silver	leg
(*)	GAMBA		leg
	CROMATO	chromed	leg
000	CROMATO	chromed	leg

PER UTILIZZO VEDI SCHEMA PAG.12
 fact-sheet , please see page 12

TAVOLI RIUNIONE PROF. CM 160 CON PIANI IN LEGNO

meeting tables deep 63" with wooden tops

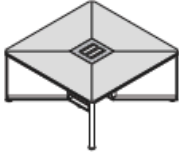
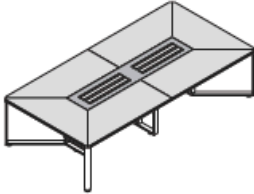
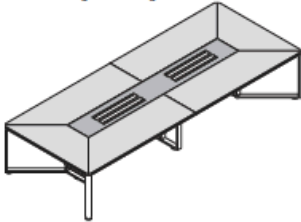
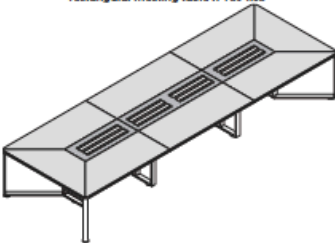
DESCRIZIONE <i>description</i>	L	w	CODICE <i>code</i>	KG	M ³	COLLI	PREZZO	CODICE FINITURA (*) <i>finish code (*)</i>		
				lb	ft ³	pcs	price			
TAVOLO RIUNIONE QUADRATO L.160x160 <i>squared meeting table w 63"x63"</i>  L.160 x p.160 x H.75 <i>w 63" x d 63" x h 29½"</i>			GAMBE VERNICIATE <i>painted legs</i>			12				
			L.160 w 63"	146 548 (*)					144 317	0,399 14,10
			GAMBE CROMATE <i>chromed legs</i>							
			L.160 w 63"	146 648 (*)						
TAVOLO RIUNIONE RETTANGOLARE L.320x160 <i>rectangular meeting table w 126"x63"</i>  L.320 x p.160 x H.75 <i>w 126" x d 63" x h 29½"</i>			GAMBE VERNICIATE <i>painted legs</i>			20				
			L.320 w 126"	146 549 (*)					262 577	0,759 26,82
			GAMBE CROMATE <i>chromed legs</i>							
			L.320 w 126"	146 649 (*)						
TAVOLO RIUNIONE RETTANGOLARE L.400x160 <i>rectangular meeting table w 157½"x63"</i>  L.400 x p.160 x H.75 <i>w 157½" x d 63" x h 29½"</i>			GAMBE VERNICIATE <i>painted legs</i>			20				
			L.400 w 157½"	146 550 (*)					305 672	0,898 31,73
			GAMBE CROMATE <i>chromed legs</i>							
			L.400 w 157½"	146 650 (*)						
TAVOLO RIUNIONE RETTANGOLARE L.480x160 <i>rectangular meeting table w 189"x63"</i>  L.480 x p.160 x H.75 <i>w 189" x d 63" x h 29½"</i>			GAMBE VERNICIATE <i>painted legs</i>			29				
			L.480 w 189"	146 551 (*)					380 827	1,123 39,68
			GAMBE CROMATE <i>chromed legs</i>							
			L.480 w 189"	146 651 (*)						

VERSIONE LEGNO <i>wooden version</i>			
(*)	PIANO	CONTENITORE WIRE MANAGEMENT E INSERITO CENTRALE	top w/o management container and central top
100	NOCE	NOCE	walnut walnut
200	ACERO TAKI	ACERO TAKI	taki maple taki maple
240	BIANCO BR.	ACERO TAKI	br. white taki maple
400	BIANCO BR.	BIANCO BR.	br. white br. white
420	ACERO TAKI	BIANCO BR.	taki maple br. white
470	LARICE MOKA	BIANCO BR.	moka larch br. white
490	WENGE'	BIANCO BR.	wenge' br. white
700	LARICE MOKA	LARICE MOKA	moka larch moka larch
740	BIANCO BR.	LARICE MOKA	br. white moka larch
800	LARICE SABBIA	LARICE SABBIA	sand larch sand larch
840	BIANCO BR.	LARICE SABBIA	br. white sand larch
870	LARICE MOKA	LARICE SABBIA	moka larch sand larch
900	WENGE'	WENGE'	wenge' wenge'
940	BIANCO BR.	WENGE'	br. white wenge'

ELEMENTI COMPONENTI PER TAVOLI RIUNIONE PROF. CM 160 CON PIANI IN LEGNO
modular elements for meeting tables deep 63" with wooden tops

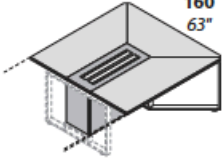
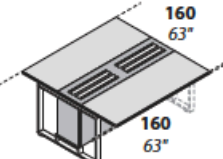
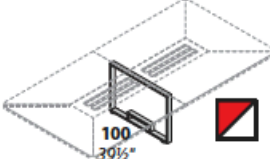
DESCRIZIONE <i>description</i>	L	w	CODICE <i>code</i>	KG	M ³	COLLI <i>pcs</i>	PREZZO <i>price</i>	CODICE FINITURA (*) <i>finish code (*)</i>				
				lb	ft ³							
MODULO TERMINALE SINGOLO PROF. CM 160 (DX o SX) <i>single terminal module deep 63" (right or left)</i>  L.160 x p.160 x H.75 <i>w 63" x d 63" x h 29 1/2"</i>			GAMBE VERNICIATE <i>painted legs</i>					VERSIONE LEGNO <i>wooden version</i>				
	L.160	w63"	146 552 (*)	128,5 282	0,344 12,16	10		(*)	CONTENITORE WIRE MANAGEMENT E INSEKTO CENTRALE	wire management cushion and central top		
			GAMBE CROMATE <i>chromed legs</i>						PIANO	top		
	L.160	w63"	146 652 (*)	128,5 282	0,344 12,16	10		100	NOCE	NOCE	walnut	walnut
MODULO CENTRALE PROF. CM 160 <i>central module deep 63"</i>  L.160 x p.160 x H.75 <i>w 63" x d 63" x h 29 1/2"</i>			GAMBE VERNICIATE <i>painted legs</i>					200	ACERO TAKI	ACERO TAKI	taki maple	taki maple
	L.160	w63"	146 554 (*)	115 252	0,363 12,83	8		240	BIANCO BR.	ACERO TAKI	bc white	taki maple
			GAMBE CROMATE <i>chromed legs</i>					400	BIANCO BR.	BIANCO BR.	bc white	bc white
	L.160	w63"	146 654 (*)	115 252	0,363 12,83	8		420	ACERO TAKI	BIANCO BR.	taki maple	bc white
GAMBA CENTRALE PER PIANI PROF. CM 160 <i>central leg for tops deep 63"</i>  L.7 x p.100 x H.72 <i>w 2 3/4" x d 39 1/2" x h 28 1/4"</i>			GAMBE VERNICIATE <i>painted legs</i>					470	LARICE MOKA	BIANCO BR.	moka larch	bc white
			146 585 (*)	8 17	0,069 2,44	1		490	WENGE'	BIANCO BR.	wenge'	bc white
			GAMBE CROMATE <i>chromed legs</i>					700	LARICE MOKA	LARICE MOKA	moka larch	moka larch
			146 685 (*)	8 17	0,069 2,44	1		740	BIANCO BR.	LARICE MOKA	bc white	moka larch
PER UTILIZZO VEDI SCHEMA PAG. 12												
fact-sheet , please see page 12												
								800	LARICE SABBIA	LARICE SABBIA	sand larch	sand larch
								840	BIANCO BR.	LARICE SABBIA	bc white	sand larch
								870	LARICE MOKA	LARICE SABBIA	moka larch	sand larch
								900	WENGE'	WENGE'	wenge'	wenge'
								940	BIANCO BR.	WENGE'	bc white	wenge'
								(*)	GAMBA	lg		
								300	ARGENTO METALLIZZATO	metallic silver		
								(*)	GAMBA	lg		
								000	CROMATO	chromed		

TAVOLI RIUNIONE PROF. CM 320 CON PIANI IN LEGNO

meeting tables deep 126" with wooden tops

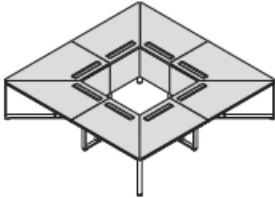
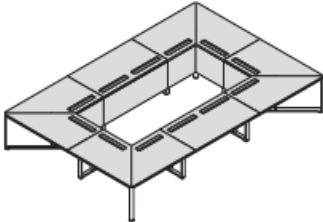
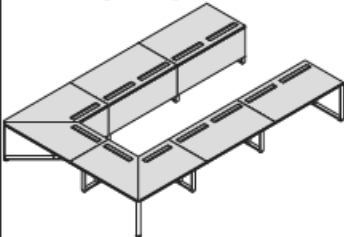
DESCRIZIONE <i>description</i>	L	w	CODICE <i>code</i>	KG	M ³	COLLI <i>pcs</i>	PREZZO <i>price</i>	CODICE FINITURA (*) <i>finish code (*)</i>
				lb	ft ³			
TAVOLO RIUNIONE QUADRATO L.320x320 <i>squared meeting table w 126"x126"</i>  L.320 x p.320 x H.75 <i>w 126" x d 126" x h 29½"</i>	L.320	w 126"	GAMBE VERNICIATE <i>painte legs</i>	462	1,839	44		
			146 556 (*)	1018	64,98			
	L.320	w 126"	GAMBE CROMATE <i>chromed legs</i>	462	1,839	44		
			146 656 (*)	1018	64,98			
TAVOLO RIUNIONE RETTANGOLARE L.480x320 <i>rectangular meeting table w 189"x126"</i>  L.480 x p.320 x H.75 <i>w 189" x d 126" x h 29½"</i>	L.480	w 189"	GAMBE VERNICIATE <i>painte legs</i>	622	2,300	54		
			146 558 (*)	1371	81,27			
	L.480	w 189"	GAMBE CROMATE <i>chromed legs</i>	622	2,300	54		
			146 658 (*)	1371	81,27			
TAVOLO RIUNIONE RETTANGOLARE L.480x320 <i>rectangular meeting table w 189"x126"</i>  L.480 x p.320 x H.75 <i>w 189" x d 126" x h 29½"</i>	L.480	w 189"	GAMBE VERNICIATE <i>painte legs</i>	558	1,905	43		
			146 559 (*)	1230	67,31			
	L.480	w 189"	GAMBE CROMATE <i>chromed legs</i>	558	1,905	43		
			146 659 (*)	1230	67,31			

VERSIONE LEGNO <i>wooden version</i>		
(*)	PIANO E CONTENITORE <i>WIRE-MANAGEMENT</i>	top and wire-management <i>container</i>
100	NOCE	walnut
200	ACERO TAKI	taki maple
400	BIANCO BR.	br. white
700	LARICE MOKKA	moka larch
800	LARICE SABBIA	sand larch
900	WENGE'	wenge'

ELEMENTI COMPONENTI PER TAVOLI RIUNIONE PROF. CM 320 CON PIANI IN LEGNO
modular elements for meeting tables deep 126" with wooden tops

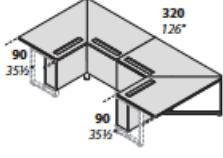
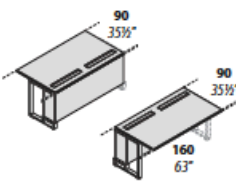
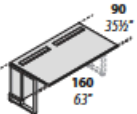
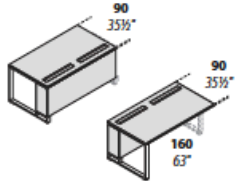
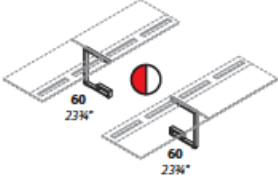
DESCRIZIONE <i>description</i>	L	w	CODICE <i>code</i>	KG	M ³	COLLI	PREZZO	CODICE FINITURA (*) <i>finish code (*)</i>
				lb	ft ³	pcs	price	
MODULO TERMINALE DOPPIO PROF. CM 320 <i>double terminal module deep 126"</i>  L.160 x p.320 x H.75 <i>w 63" x d 126" x h 29 1/2"</i>			GAMBE VERNICIATE <i>painte d legs</i>	227	0,913	22		
	L.160	w 63"	146 560 (*)	500	22,26			
			GAMBE CROMATE <i>chrome d legs</i>	227	0,913	22		
	L.160	w 63"	146 660 (*)	500	22,26			
KIT 2 MODULI CENTRALI PROF. CM 90 <i>kit of 2 central modules deep 35 1/2"</i>  L.160 x p.90 x H.75 <i>w 63" x d 35 1/2" x h 29 1/2"</i>			GAMBE VERNICIATE <i>painte d legs</i>	160	0,461	10		
	L.160	w 63"	146 562 (*)	352	16,29			
			GAMBE CROMATE <i>chrome d legs</i>	160	0,461	10		
	L.160	w 63"	146 662 (*)	352	16,29			
KIT 1 MODULO CENTRALE PROF. CM 90 <i>kit of 1 central module deep 35 1/2"</i>  L.160 x p.90 x H.75 <i>w 63" x d 35 1/2" x h 29 1/2"</i>			GAMBE VERNICIATE <i>painte d legs</i>	81	0,252	6		
	L.160	w 63"	146 564 (*)	178	8,90			
			GAMBE CROMATE <i>chrome d legs</i>	81	0,252	6		
	L.160	w 63"	146 664 (*)	178	8,90			
KIT 2 MODULI TERMINALI PROF. CM 90 <i>kit of 2 terminal modules deep 35 1/2"</i>  L.160 x p.90 x H.75 <i>w 63" x d 35 1/2" x h 29 1/2"</i>			GAMBE VERNICIATE <i>painte d legs</i>	162	0,483	10		
	L.160	w 63"	146 566 (*)	357	17,07			
			GAMBE CROMATE <i>chrome d legs</i>	162	0,483	10		
	L.160	w 63"	146 666 (*)	357	17,07			
KIT 2 GAMBE CENTRALI PER PIANI PROF. CM 90 <i>kit of 2 central metal legs for tops deep 35 1/2"</i>  L.7 x p.60 x H.72 <i>w 23 3/4" x d 23 3/4" x h 28 1/4"</i>			GAMBE VERNICIATE <i>painte d legs</i>	9	0,046	1		
			146 586 (*)	19	1,63			
			GAMBE CROMATE <i>chrome d legs</i>	9	0,046	1		
			146 686 (*)	19	1,63			
PER UTILIZZO VEDI SCHEMA PAG. 12 fact-sheet , please see page 12								

VERSIONE LEGNO
wooden version

(*)	PIANO E CONTENITORE WIRE-MANAGEMENT	top and wire-management container
100	NOCE	walnut
200	ACERO TAKI	taki maple
400	BIANCO BR.	br. white
700	LARICE NOKA	noka larch
800	LARICE SABBIA	sand larch
900	WENGE	wenge

(*)	GAMBA	leg
300	ARGENTO METALLIZZATO	metallic silver
(*)	GAMBA	leg
000	CROMATO	chrome

TAVOLI RIUNIONE PROF. CM 160 CON PIANI IN CRISTALLO

meeting tables deep 63" with crystal tops

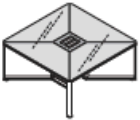
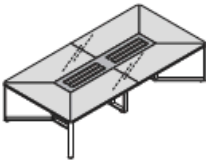
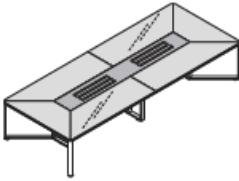
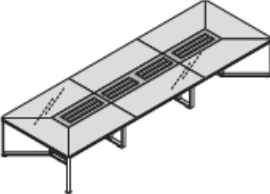
DESCRIZIONE <i>description</i>	L	w	CODICE <i>code</i>	KG	M ³	COLLI <i>pcs</i>	PREZZO <i>price</i>	CODICE FINITURA (*) <i>finish code (*)</i>																																																																																																											
				lb	ft ³																																																																																																														
TAVOLO RIUNIONE QUADRATO L.160x160 <i>squared meeting table w 63"x63"</i>  L.160 x p.160 x H.75 <i>w 63" x d 63" x h 29½"</i>			GAMBE VERNICIATE <i>painted legs</i>	L.160 w63"	146	518 (*)	159,6 351	0,406 14,35	12																																																																																																										
			GAMBE CROMATE <i>chromed legs</i>	L.160 w63"	146	618 (*)	159,6 351	0,406 14,35	12																																																																																																										
TAVOLO RIUNIONE RETTANGOLARE L.320x160 <i>rectangular meeting table w 126"x63"</i>  L.320 x p.160 x H.75 <i>w 126" x d 63" x h 29½"</i>			GAMBE VERNICIATE <i>painted legs</i>	L.320 w126"	146	519 (*)	283,2 624	0,772 27,28	20	VERSIONE CRISTALLO <i>crystal version</i> <table border="1"> <thead> <tr> <th>(*)</th> <th>PIANO</th> <th>CONTENITORE WIRE MANAGEMENT E INSERTO CENTRALE</th> <th>top</th> <th>wire management outside and central top</th> </tr> </thead> <tbody> <tr><td>110</td><td>NERO</td><td>NOCE</td><td>black</td><td>walnut</td></tr> <tr><td>173</td><td>VANIGLIA</td><td>NOCE</td><td>vanilla</td><td>walnut</td></tr> <tr><td>210</td><td>NERO</td><td>ACERO TAKI</td><td>black</td><td>tbl maple</td></tr> <tr><td>274</td><td>ROSSO RUBINO</td><td>ACERO TAKI</td><td>rsby rad</td><td>tbl maple</td></tr> <tr><td>275</td><td>PISTACCHIO</td><td>ACERO TAKI</td><td>piستachio</td><td>tbl maple</td></tr> <tr><td>410</td><td>NERO</td><td>BIANCO BR.</td><td>black</td><td>bc white</td></tr> <tr><td>474</td><td>ROSSO RUBINO</td><td>BIANCO BR.</td><td>rsby rad</td><td>bc white</td></tr> <tr><td>475</td><td>PISTACCHIO</td><td>BIANCO BR.</td><td>piستachio</td><td>bc white</td></tr> <tr><td>710</td><td>NERO</td><td>LARICE MOKA</td><td>black</td><td>moka larch</td></tr> <tr><td>773</td><td>VANIGLIA</td><td>LARICE MOKA</td><td>vanilla</td><td>moka larch</td></tr> <tr><td>774</td><td>ROSSO RUBINO</td><td>LARICE MOKA</td><td>rsby rad</td><td>moka larch</td></tr> <tr><td>775</td><td>PISTACCHIO</td><td>LARICE MOKA</td><td>piستachio</td><td>moka larch</td></tr> <tr><td>810</td><td>NERO</td><td>LARICE SABBIA</td><td>black</td><td>sand larch</td></tr> <tr><td>873</td><td>VANIGLIA</td><td>LARICE SABBIA</td><td>vanilla</td><td>sand larch</td></tr> <tr><td>874</td><td>ROSSO RUBINO</td><td>LARICE SABBIA</td><td>rsby rad</td><td>sand larch</td></tr> <tr><td>875</td><td>PISTACCHIO</td><td>LARICE SABBIA</td><td>piستachio</td><td>sand larch</td></tr> <tr><td>910</td><td>NERO</td><td>WENGE'</td><td>black</td><td>wangi</td></tr> <tr><td>973</td><td>VANIGLIA</td><td>WENGE'</td><td>vanilla</td><td>wangi</td></tr> <tr><td>974</td><td>ROSSO RUBINO</td><td>WENGE'</td><td>rsby rad</td><td>wangi</td></tr> <tr><td>975</td><td>PISTACCHIO</td><td>WENGE'</td><td>piستachio</td><td>wangi</td></tr> </tbody> </table>	(*)	PIANO	CONTENITORE WIRE MANAGEMENT E INSERTO CENTRALE	top	wire management outside and central top	110	NERO	NOCE	black	walnut	173	VANIGLIA	NOCE	vanilla	walnut	210	NERO	ACERO TAKI	black	tbl maple	274	ROSSO RUBINO	ACERO TAKI	rsby rad	tbl maple	275	PISTACCHIO	ACERO TAKI	piستachio	tbl maple	410	NERO	BIANCO BR.	black	bc white	474	ROSSO RUBINO	BIANCO BR.	rsby rad	bc white	475	PISTACCHIO	BIANCO BR.	piستachio	bc white	710	NERO	LARICE MOKA	black	moka larch	773	VANIGLIA	LARICE MOKA	vanilla	moka larch	774	ROSSO RUBINO	LARICE MOKA	rsby rad	moka larch	775	PISTACCHIO	LARICE MOKA	piستachio	moka larch	810	NERO	LARICE SABBIA	black	sand larch	873	VANIGLIA	LARICE SABBIA	vanilla	sand larch	874	ROSSO RUBINO	LARICE SABBIA	rsby rad	sand larch	875	PISTACCHIO	LARICE SABBIA	piستachio	sand larch	910	NERO	WENGE'	black	wangi	973	VANIGLIA	WENGE'	vanilla	wangi	974	ROSSO RUBINO	WENGE'	rsby rad	wangi	975	PISTACCHIO	WENGE'	piستachio	wangi
			(*)	PIANO	CONTENITORE WIRE MANAGEMENT E INSERTO CENTRALE	top	wire management outside and central top																																																																																																												
110	NERO	NOCE	black	walnut																																																																																																															
173	VANIGLIA	NOCE	vanilla	walnut																																																																																																															
210	NERO	ACERO TAKI	black	tbl maple																																																																																																															
274	ROSSO RUBINO	ACERO TAKI	rsby rad	tbl maple																																																																																																															
275	PISTACCHIO	ACERO TAKI	piستachio	tbl maple																																																																																																															
410	NERO	BIANCO BR.	black	bc white																																																																																																															
474	ROSSO RUBINO	BIANCO BR.	rsby rad	bc white																																																																																																															
475	PISTACCHIO	BIANCO BR.	piستachio	bc white																																																																																																															
710	NERO	LARICE MOKA	black	moka larch																																																																																																															
773	VANIGLIA	LARICE MOKA	vanilla	moka larch																																																																																																															
774	ROSSO RUBINO	LARICE MOKA	rsby rad	moka larch																																																																																																															
775	PISTACCHIO	LARICE MOKA	piستachio	moka larch																																																																																																															
810	NERO	LARICE SABBIA	black	sand larch																																																																																																															
873	VANIGLIA	LARICE SABBIA	vanilla	sand larch																																																																																																															
874	ROSSO RUBINO	LARICE SABBIA	rsby rad	sand larch																																																																																																															
875	PISTACCHIO	LARICE SABBIA	piستachio	sand larch																																																																																																															
910	NERO	WENGE'	black	wangi																																																																																																															
973	VANIGLIA	WENGE'	vanilla	wangi																																																																																																															
974	ROSSO RUBINO	WENGE'	rsby rad	wangi																																																																																																															
975	PISTACCHIO	WENGE'	piستachio	wangi																																																																																																															
GAMBE CROMATE <i>chromed legs</i>	L.320 w126"	146	619 (*)	283,2 624	0,772 27,28	20																																																																																																													
TAVOLO RIUNIONE RETTANGOLARE L.400x160 <i>rectangular meeting table w 157½"x63"</i>  L.400 x p.160 x H.75 <i>w 157½" x d 63" x h 29½"</i>			GAMBE VERNICIATE <i>painted legs</i>	L.400 w157½"	146	520 (*)	335 738	0,917 32,40	20																																																																																																										
			GAMBE CROMATE <i>chromed legs</i>	L.400 w157½"	146	620 (*)	335 738	0,917 32,40	20																																																																																																										
TAVOLO RIUNIONE RETTANGOLARE L.480x160 <i>rectangular meeting table w 189"x63"</i>  L.480 x p.160 x H.75 <i>w 189" x d 63" x h 29½"</i>			GAMBE VERNICIATE <i>painted legs</i>	L.480 w189"	146	521 (*)	408,8 901	1,149 40,60	29																																																																																																										
			GAMBE CROMATE <i>chromed legs</i>	L.480 w189"	146	621 (*)	408,8 901	1,149 40,60	29																																																																																																										

ELEMENTI COMPONENTI PER TAVOLI RIUNIONE PROF. CM 160 CON PIANI IN CRISTALLO
modular elements for meeting tables deep 63" with crystal tops

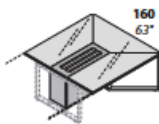
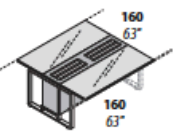
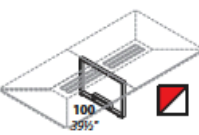
DESCRIZIONE <i>description</i>	L	w	CODICE <i>code</i>	KG	M ³	COLLI <i>pcs</i>	PREZZO <i>price</i>	CODICE FINITURA (*) <i>finish code (*)</i>																																																																																																									
				lb	ft ³																																																																																																												
MODULO TERMINALE SINGOLO PROF. CM 160 (DX o SX) <i>single terminal module deep 63" (right or left)</i>  L.160 x p.160 x H.75 <i>w 63" x d 63" x h 29 1/2"</i>			GAMBE VERNICIATE <i>painted legs</i>																																																																																																														
	L.160	w 63"	146 522 (*)	139,1 306	0,351 12,40	10																																																																																																											
			GAMBE CROMATE <i>chromed legs</i>																																																																																																														
	L.160	w 63"	146 622 (*)	139,1 306	0,351 12,40	10																																																																																																											
	MODULO CENTRALE PROF. CM 160 <i>central module deep 63"</i>  L.160 x p.160 x H.75 <i>w 63" x d 63" x h 29 1/2"</i>			GAMBE VERNICIATE <i>painted legs</i>																																																																																																													
		L.160	w 63"	146 524 (*)	122,6 270	0,376 13,29	8																																																																																																										
			GAMBE CROMATE <i>chromed legs</i>																																																																																																														
L.160		w 63"	146 624 (*)	122,6 270	0,376 13,29	8																																																																																																											
GAMBA CENTRALE PER PIANI PROF. CM 160 <i>central leg for tops deep 63"</i>  L.7 x p.100 x H.72 <i>w 2 3/4" x d 39 1/2" x h 28 3/4"</i>				GAMBE VERNICIATE <i>painted legs</i>																																																																																																													
				146 585 (*)	8 17	0,069 2,44	1																																																																																																										
			GAMBE CROMATE <i>chromed legs</i>																																																																																																														
			146 685 (*)	8 17	0,069 2,44	1																																																																																																											
	VERSIONE CRISTALLO <i>crystal version</i>																																																																																																																
									<table border="1"> <thead> <tr> <th>(*)</th> <th>PIANO</th> <th>CONTENITORE WIRE MANAGEMENT E INSERTO CENTRALE</th> <th>top</th> <th>wire management container and central top</th> </tr> </thead> <tbody> <tr><td>110</td><td>NERO</td><td>NOCE</td><td>black</td><td>walnut</td></tr> <tr><td>173</td><td>VANGLIA</td><td>NOCE</td><td>vanilla</td><td>walnut</td></tr> <tr><td>210</td><td>NERO</td><td>ACERO TAKI</td><td>black</td><td>tbl maple</td></tr> <tr><td>274</td><td>ROSSO RUBINO</td><td>ACERO TAKI</td><td>ruby red</td><td>tbl maple</td></tr> <tr><td>275</td><td>PISTACCHIO</td><td>ACERO TAKI</td><td> pistachio</td><td>tbl maple</td></tr> <tr><td>410</td><td>NERO</td><td>BIANCO BR.</td><td>black</td><td>bc white</td></tr> <tr><td>474</td><td>ROSSO RUBINO</td><td>BIANCO BR.</td><td>ruby red</td><td>bc white</td></tr> <tr><td>475</td><td>PISTACCHIO</td><td>BIANCO BR.</td><td> pistachio</td><td>bc white</td></tr> <tr><td>710</td><td>NERO</td><td>LARICE MOKA</td><td>black</td><td>moka larch</td></tr> <tr><td>773</td><td>VANGLIA</td><td>LARICE MOKA</td><td>vanilla</td><td>moka larch</td></tr> <tr><td>774</td><td>ROSSO RUBINO</td><td>LARICE MOKA</td><td>ruby red</td><td>moka larch</td></tr> <tr><td>775</td><td>PISTACCHIO</td><td>LARICE MOKA</td><td> pistachio</td><td>moka larch</td></tr> <tr><td>810</td><td>NERO</td><td>LARICE SABBIA</td><td>black</td><td>sand larch</td></tr> <tr><td>873</td><td>VANGLIA</td><td>LARICE SABBIA</td><td>vanilla</td><td>sand larch</td></tr> <tr><td>874</td><td>ROSSO RUBINO</td><td>LARICE SABBIA</td><td>ruby red</td><td>sand larch</td></tr> <tr><td>875</td><td>PISTACCHIO</td><td>LARICE SABBIA</td><td> pistachio</td><td>sand larch</td></tr> <tr><td>910</td><td>NERO</td><td>'WENGE'</td><td>black</td><td>wangi</td></tr> <tr><td>973</td><td>VANGLIA</td><td>'WENGE'</td><td>vanilla</td><td>wangi</td></tr> <tr><td>974</td><td>ROSSO RUBINO</td><td>'WENGE'</td><td>ruby red</td><td>wangi</td></tr> <tr><td>975</td><td>PISTACCHIO</td><td>'WENGE'</td><td> pistachio</td><td>wangi</td></tr> </tbody> </table>	(*)	PIANO	CONTENITORE WIRE MANAGEMENT E INSERTO CENTRALE	top	wire management container and central top	110	NERO	NOCE	black	walnut	173	VANGLIA	NOCE	vanilla	walnut	210	NERO	ACERO TAKI	black	tbl maple	274	ROSSO RUBINO	ACERO TAKI	ruby red	tbl maple	275	PISTACCHIO	ACERO TAKI	pistachio	tbl maple	410	NERO	BIANCO BR.	black	bc white	474	ROSSO RUBINO	BIANCO BR.	ruby red	bc white	475	PISTACCHIO	BIANCO BR.	pistachio	bc white	710	NERO	LARICE MOKA	black	moka larch	773	VANGLIA	LARICE MOKA	vanilla	moka larch	774	ROSSO RUBINO	LARICE MOKA	ruby red	moka larch	775	PISTACCHIO	LARICE MOKA	pistachio	moka larch	810	NERO	LARICE SABBIA	black	sand larch	873	VANGLIA	LARICE SABBIA	vanilla	sand larch	874	ROSSO RUBINO	LARICE SABBIA	ruby red	sand larch	875	PISTACCHIO	LARICE SABBIA	pistachio	sand larch	910	NERO	'WENGE'	black	wangi	973	VANGLIA	'WENGE'	vanilla	wangi	974	ROSSO RUBINO	'WENGE'	ruby red	wangi	975	PISTACCHIO	'WENGE'	pistachio
(*)	PIANO	CONTENITORE WIRE MANAGEMENT E INSERTO CENTRALE	top	wire management container and central top																																																																																																													
110	NERO	NOCE	black	walnut																																																																																																													
173	VANGLIA	NOCE	vanilla	walnut																																																																																																													
210	NERO	ACERO TAKI	black	tbl maple																																																																																																													
274	ROSSO RUBINO	ACERO TAKI	ruby red	tbl maple																																																																																																													
275	PISTACCHIO	ACERO TAKI	pistachio	tbl maple																																																																																																													
410	NERO	BIANCO BR.	black	bc white																																																																																																													
474	ROSSO RUBINO	BIANCO BR.	ruby red	bc white																																																																																																													
475	PISTACCHIO	BIANCO BR.	pistachio	bc white																																																																																																													
710	NERO	LARICE MOKA	black	moka larch																																																																																																													
773	VANGLIA	LARICE MOKA	vanilla	moka larch																																																																																																													
774	ROSSO RUBINO	LARICE MOKA	ruby red	moka larch																																																																																																													
775	PISTACCHIO	LARICE MOKA	pistachio	moka larch																																																																																																													
810	NERO	LARICE SABBIA	black	sand larch																																																																																																													
873	VANGLIA	LARICE SABBIA	vanilla	sand larch																																																																																																													
874	ROSSO RUBINO	LARICE SABBIA	ruby red	sand larch																																																																																																													
875	PISTACCHIO	LARICE SABBIA	pistachio	sand larch																																																																																																													
910	NERO	'WENGE'	black	wangi																																																																																																													
973	VANGLIA	'WENGE'	vanilla	wangi																																																																																																													
974	ROSSO RUBINO	'WENGE'	ruby red	wangi																																																																																																													
975	PISTACCHIO	'WENGE'	pistachio	wangi																																																																																																													
								<table border="1"> <thead> <tr> <th>(*)</th> <th>GAMBA</th> <th>leg</th> </tr> </thead> <tbody> <tr> <td>300</td> <td>ARGENTO METALLIZZATO</td> <td>metallic silver</td> </tr> </tbody> </table>	(*)	GAMBA	leg	300	ARGENTO METALLIZZATO	metallic silver																																																																																																			
(*)	GAMBA	leg																																																																																																															
300	ARGENTO METALLIZZATO	metallic silver																																																																																																															
								<table border="1"> <thead> <tr> <th>(*)</th> <th>GAMBA</th> <th>leg</th> </tr> </thead> <tbody> <tr> <td>000</td> <td>CROMATO</td> <td>chromed</td> </tr> </tbody> </table>	(*)	GAMBA	leg	000	CROMATO	chromed																																																																																																			
(*)	GAMBA	leg																																																																																																															
000	CROMATO	chromed																																																																																																															

PER UTILIZZO VEDI SCHEMA PAG. 12
fact-sheet , please see page 12

SCHEMA DI UTILIZZO ELEMENTI COMPONENTI PER TAVOLI RIUNIONE
modular elements for meeting tables fact-sheet

AGGREGAZIONE DI 2 TERMINALI + n... MODULI CENTRALI
junction of 2 terminals + n...central modules

COMPLETARE SEMPRE LE COMPOSIZIONI CON 1 GAMBA CENTRALE ART.587-687
to be always completed by with 1 central metal leg art.587-687

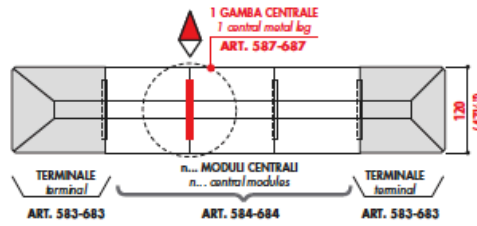
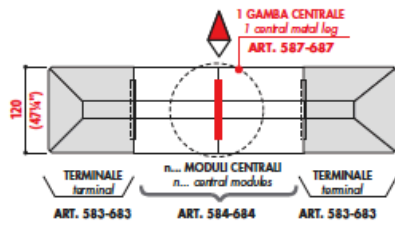

AGGREGAZIONE DI 2 TERMINALI + n... MODULI CENTRALI
junction of 2 terminals + n...central modules

COMPLETARE SEMPRE LE COMPOSIZIONI CON 1 GAMBA CENTRALE ART.585-685
to be always completed by with 1 central metal leg art.585-685

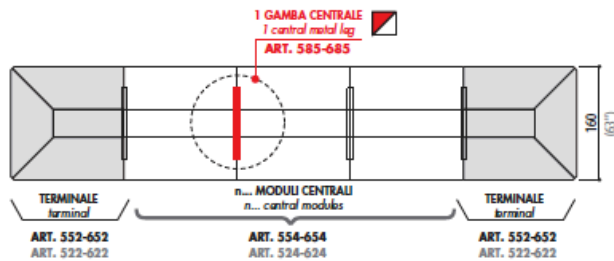
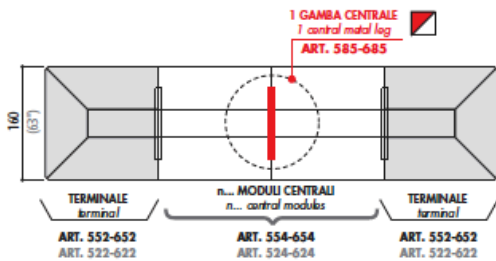

AGGREGAZIONE DI TERMINALI + n... MODULI CENTRALI DOPPI
junction of 2 terminals + n...double central modules

COMPLETARE SEMPRE LE COMPOSIZIONI CON 1 KIT 2 GAMBE CENTRALI ART.586-686
to be always completed by with 1 kit of 2 central metal legs art.586-686

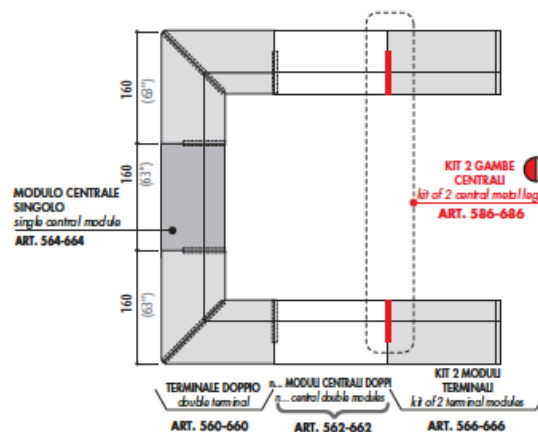
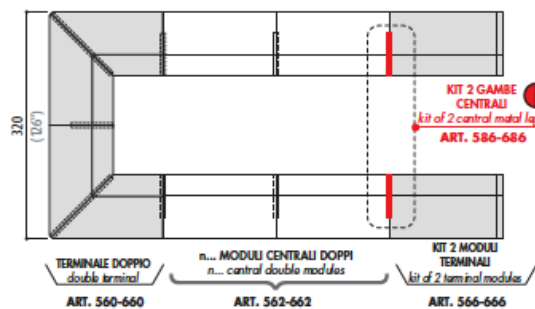
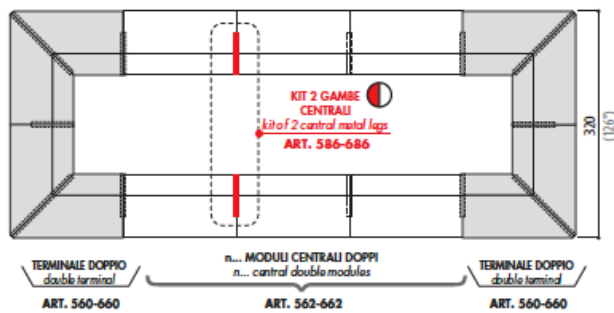
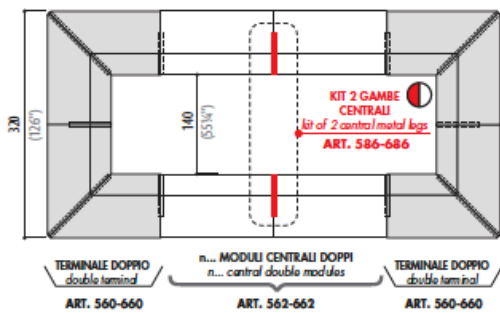

COMPLEMENTI DI ARREDO
accessories

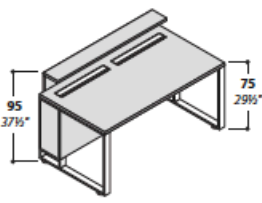
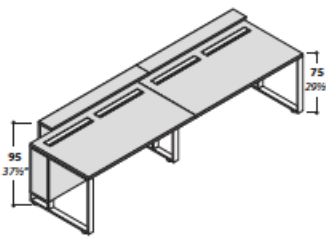
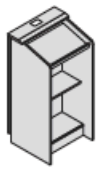
DESCRIZIONE <i>description</i>	L	w	CODICE <i>code</i>	KG	M ³	COLLI	PREZZO <i>price</i>	CODICE FINITURA (*) <i>finish code (*)</i>
				lb	ft ³	pcs		
CATTEDRA SINGOLA <i>single conference desk</i>  L.160 x p.91 x H.75-95 w 63" x d 35 3/4" x h 29 1/2"-37 1/2"			GAMBE VERNICIATE <i>painted legs</i>					
	L.160 w 63"		146 568 (*)	111 244	0,340 12,07	7		
			GAMBE CROMATE <i>chromed legs</i>					
	L.160 w 63"		146 668 (*)	111 244	0,340 12,07	7		
CATTEDRA DOPPIA <i>double conference desk</i>  L.320 x p.91 x H.75-95 w 126" x d 35 3/4" x h 29 1/2"-37 1/2"			GAMBE VERNICIATE <i>painted legs</i>					
	L.320 w 126"		146 569 (*)	214 471	0,644 22,75	12		
			GAMBE CROMATE <i>chromed legs</i>					
	L.320 w 126"		146 669 (*)	214 471	0,644 22,75	12		
LEGGIO <i>lectern</i>  L.58 x p.54 x H.125 w 22 3/4" x d 21 3/4" x h 49 3/4"			146 571 (*)	59 130	0,151 5,34	3		

(*)		
100	NOCE	walnut
200	ACERO TAKI	taki maple
400	BIANCO BR.	br. white
700	LARICE MOKA	moka larch
800	LARICE SABBIA	sand larch
900	WENGE'	wenge

DIMENSIONI
dimensions

prof. cm 120
(depth 47 1/4")



ART. 514-614



ART. 544-644

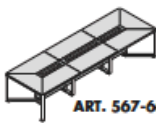

ART. 567-667

- SEZIONE VERTICALE -
- vertical section -

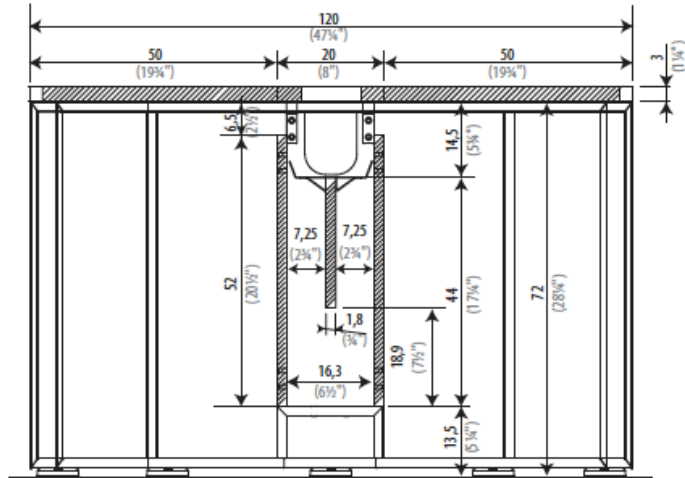

prof. cm 160
(depth 63")



ART. 548-648
ART. 518-618



ART. 549-649
ART. 519-619



ART. 550-650
ART. 520-620



ART. 551-651
ART. 521-621

- SEZIONE VERTICALE -
- vertical section -

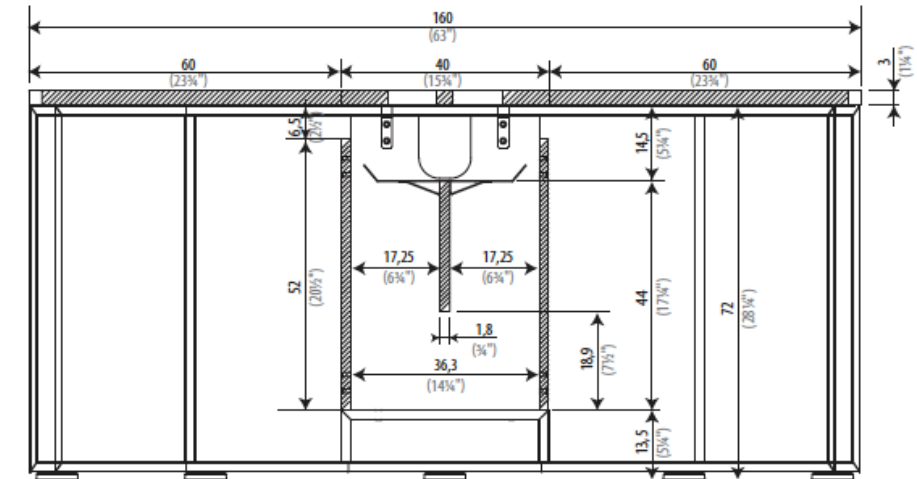

prof. cm 90
(depth 35 1/2")

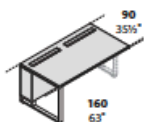

MODULI TERMINALI
terminal modules

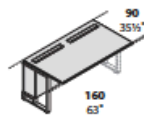

MODULI CENTRALI
central modules

- SEZIONE VERTICALE -
- vertical section -

